

MIKRON
HSM 400 LP
HSM 400U LP
HSM 500 LP
HSM 600 LP
HSM 600U LP
HSM 800 LP



MIKRON HSM 400 LP / 500 LP

MIKRON HSM 400U LP

High-speed milling - universal approach to mold-making and production

Contents

Applications		Interface for automation systems	20
3-axis	4	High-tech motor spindle	22
5-axis	6	Tool magazine	23
Highlights	8	Chip and Dust management	24
Table versions	10	Option: ProdMod	26
Basic machine	11	Options	28
Feed axes	12	smart machine	29
Precision	13	About GF AgieCharmilles	30
Automation	18		

GF AgieCharmilles presents new reference machines in 3-axis and 5-axis versions for high-speed milling.

Based on the concept of the present HSM series, GF AgieCharmilles engineers have developed three new machine models which represent

optimal answers to all aspects of 3-axis and 5-axis high-speed milling needs. The HSM LP series (LP = Linear Performance) were designed for ultimate precision and supreme surface quality. The necessary design measures focus on the machine bed, cooling, axis drives, motion control and tool measurement.

These vertical high-speed machining centers, developed for tool and mold manufacturing as well as medium- and small-series production of high-quality parts, combine the Swiss machine manufacturer's entire technical expertise and extensive development experience. GF AgieCharmilles.



MIKRON HSM 600 LP / 800 LP



MIKRON HSM 600U LP

Applications

3-axis

MIKRON HSM 400 LP
 MIKRON HSM 500 LP
 MIKRON HSM 600 LP
 MIKRON HSM 800 LP

Watch components

MIKRON HSM 400 LP

Different materials

Watch making industry/ micro-mechanics

- Shape accuracy
- Smallest geometries
- Parts-specific handling systems



Graphite electrode

MIKRON HSM 600 LP

Graphite

Mold making

- High contour accuracy
- Efficient graphite machining

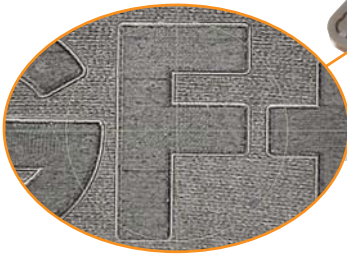
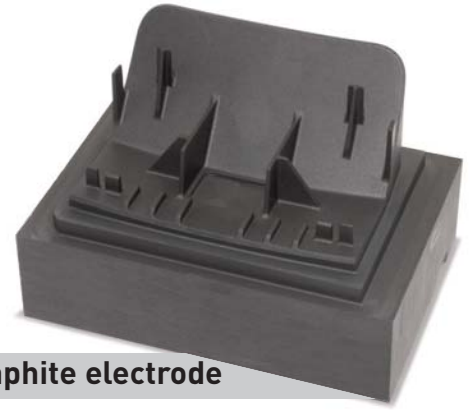

Electrode

MIKRON HSM 400 LP

Tungsten-copper

Tool and mold manufacturing

- High surface quality
- Shape accuracy
- Very small geometry features

Die

MIKRON HSM 800 LP

Alloyed tool steel

Tool and mold making

- Surface quality
- Shape accuracy
- Positional accuracy



Ball screw drive

Linear direct drive

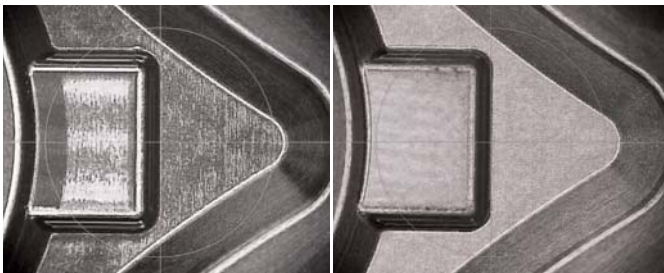

HSC milling of a prototype mold insert





Applications

5-axis

MIKRON HSM 400U LP
MIKRON HSM 600U LP

Impeller

MIKRON HSM 600U LP

Titanium

Automobile industry

- 5-axis simultaneous machining
- High vibration damping
- Strong cutting ability

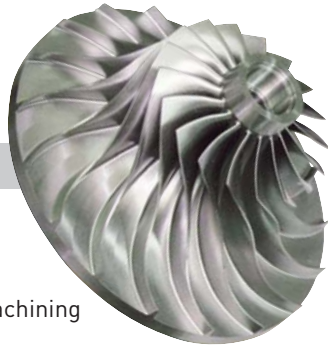

MedTech

MIKRON HSM 400U LP

Titanium / CoCr

Medical technology

- Adequate spindle performance
- Process stability
- 5-axis simultaneous machining 24/7
- Greatly improved tool life

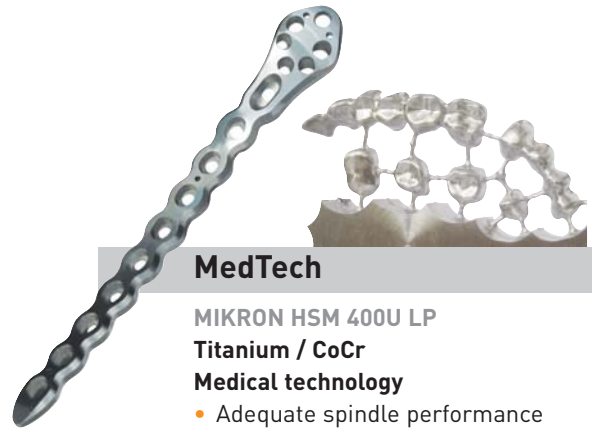

Tire mold

MIKRON HSM 600U LP

Aluminium

Automobile industry

- 5-axis simultaneous machining
- High feed rates
- Thin-walled geometries

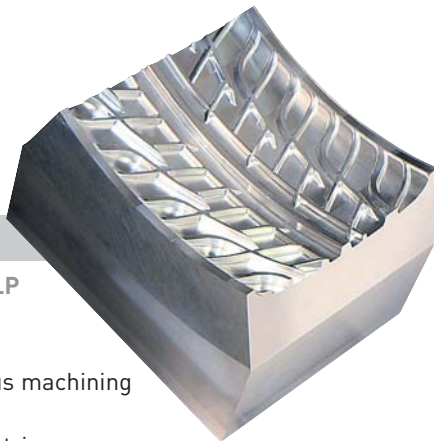

Casting mold

MIKRON HSM 400U LP

Alloyed tool steel

Tool and mold making

- High surface quality
- 5-axis simultaneous machining of thread with undercut section

Closed impeller

MIKRON HSM 400U LP

Aluminium

Automobile industry

- 5-axis simultaneous machining
- Perfect kinematics insure machining of complicated geometries



Machining of mold work in
5-axis simultaneous operation



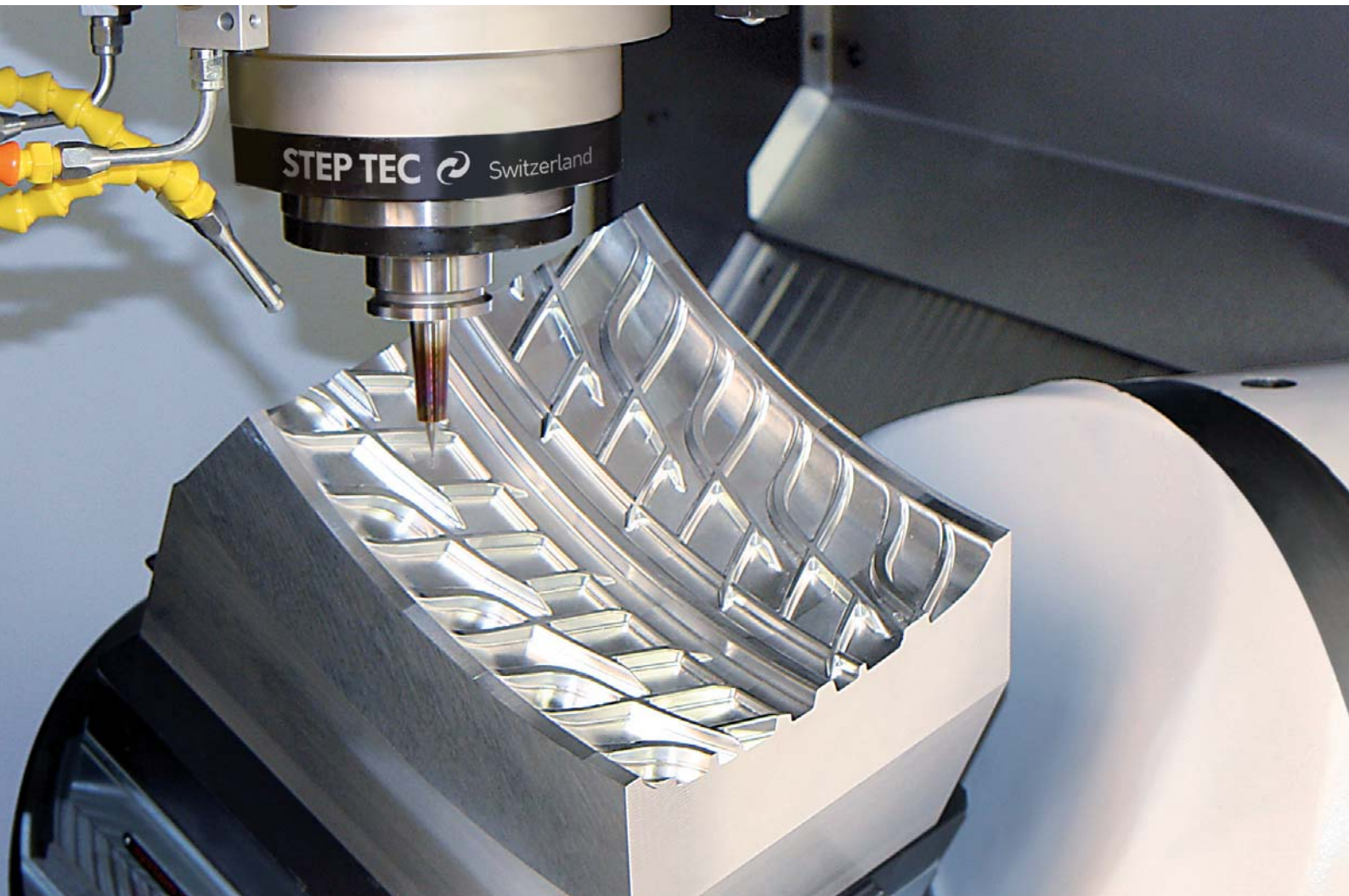

Highlights

Precision and quality for tool- and mold-making
as well as accurate part manufacturing

MIKRON HSM 400U LP

Crane loading

Machine hood
for thermal
and acoustic
insulation

High-
performance
machine control

Robust tool spindle with vector control
and ceramic hybrid bearings

Flexible
workpiece
automation

Direct drives
on all axes:
X, Y, Z, B, C



MIKRON
HSM 400 LP
HSM 500 LP

Stability and damping

Primary prerequisites for maximum precision and best workpiece surface quality include damping and stability of the components:

- Monolithic design
- Highly stable portal construction
- Machine base of mineral cast with high damping characteristics
- Optimised force distribution within castings



The MIKRON HSM LP series impresses with the unrivalled accessibility, regardless of their particular configuration

MIKRON HSM 600U LP

Crane loading

High-performance machine control

Robust tool spindle with vector control and ceramic hybrid bearings

Direct drives on all axes:
X, Y, Z, B, C

Flexible workpiece automation



Ergonomics and process reliability

...are key features of this machine series:

- Equally accessible in all upgrade levels - thanks to workpiece automation via the portal
- Excellent view into the workspace
- Access to the workpiece from three sides
- Crane loading
- Side window to optimally monitor machining

MIKRON
HSM 600 LP
HSM 800 LP

Table versions

As flexible as needed

3 axis versions

Machine tool size
Travel X, Y, Z: 500 x 450 x 360 mm

MIKRON HSM 500 LP 200 kg



MIKRON HSM 400 LP 120 kg

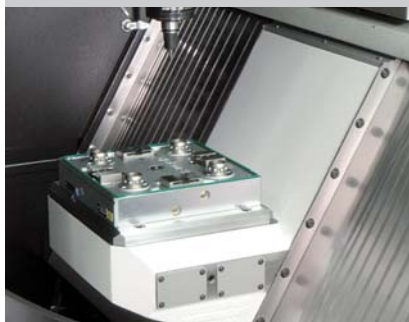

MIKRON HSM 400 LP with chuck
 • System 3R Dynafix
 • System 3R GPS
 • Erowa UPC

Machine tool size
Travel X, Y, Z: 600/800x600x500 mm

MIKRON HSM 600 LP 500 kg
MIKRON HSM 800 LP 1000 kg



MIKRON HSM 600 LP 500 kg
MIKRON HSM 800 LP 800 kg



MIKRON HSM 600/800 LP with chuck

Greatly reduces unproductive times
 Fully integrated zero-point clamping systems from manufacturers System 3R and Erowa.

5 axis versions

MIKRON HSM 400U LP 25 kg



Round tilting table with chuck
 • System 3R Macro Magnum
 • Erowa ITS

MIKRON HSM 600U LP 120 kg



Round tilting table with chuck
 • System 3R Dynafix
 • System 3R GPS
 • Erowa UPC

- Extremely dynamic and fast: Rotation and swivelling with direct drives in the B and C axis up to 250 min⁻¹
- Extremely accurate and precise: Liquid-cooled motors and absolute measuring systems
- Extremely stable and flexible: hydraulic clamping in the rotation and swivel axis plus integrated zero-point clamping system with a B-axis swivel range up to 220°

Basic machine

For uncompromising demands

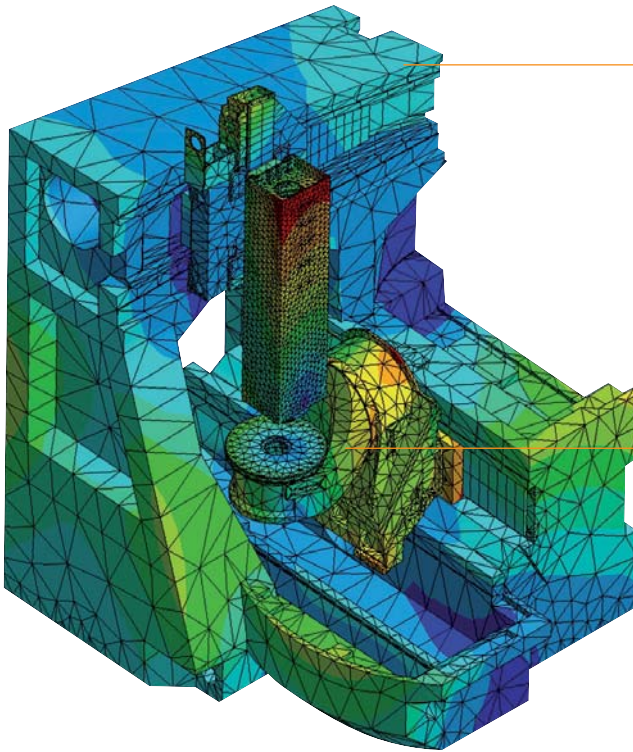

Polymer concrete

The polymer concrete features high thermal inertia and excellent damping properties.

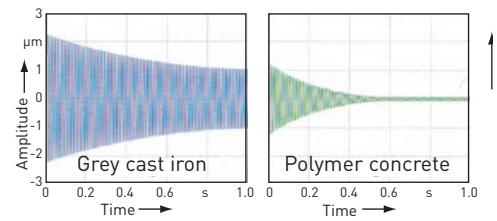

Moving slides

The weight and rigidity of the cross slide are optimised to stand up to the high dynamic requirements.

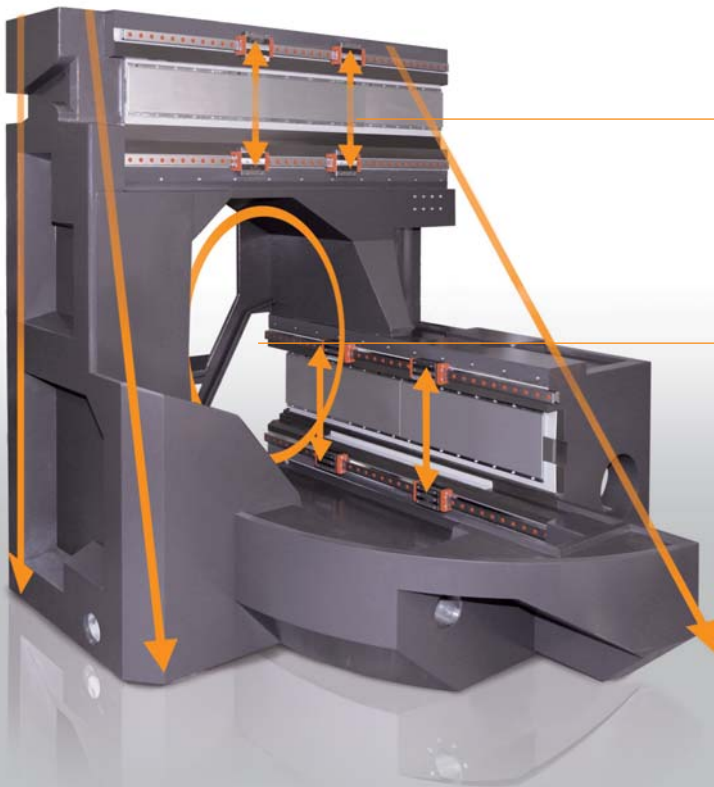

Pyramidal construction

The pyramidal structure ensures both optimal dynamic to static mass distribution and a perfect distribution of cutting forces.

Closed structure

The O-shaped portal is outstandingly suitable for automation solutions by GF AgieCharmilles or other manufacturers.



Dynamics and precision

Mechanical drive systems have a basic disadvantage: a loss of precision must be accepted to achieve a highly dynamic configuration. This effect is not relevant for customers in auxiliary motions such as tool changing or axial positioning. An HSC machine changes the situation: During cutting control, high dynamics must be combined with great precision. This is where the linear direct drive shows all its advantages.

- Short setting time
- No oversteering through drive play and elasticity
- High dynamic rigidity of the attitude control
- Independent of slide position

Advantages

- Outstandingly precise, accurate workpiece machining due to the extremely rigid drive and control concept.
- Excellent long-term precision due to the reduction of friction-induced wear by the direct drive and central oil lubrication
- Reduction of main operating times due to extremely high dynamic parameterisation (OSS)
- Reduction of auxiliary times by high rapid-traverse speeds
- Reduction of maintenance and servicing, since the lack of ball screw drives or transmissions reduces the number of wearing parts.

Central oil lubrication

Linear direct drive



Precision

HSC core components: Static and dynamic precision

Static precision

Swiss thoroughness

Before delivery, every MIKRON HSM LP machine undergoes an extensive quality check in our air-conditioned assembly hall in accordance with GF AgieCharmilles acceptance guidelines.

Quality-consciousness means added value.

Dynamic precision

Path measurement systems

Direct path measurement systems in the linear and rotational axes are standard equipment on all MIKRON HSM LP machines.

- Tried and tested Heidenhain precision
- Resolution in the nanometer range
- Protected by sealing air

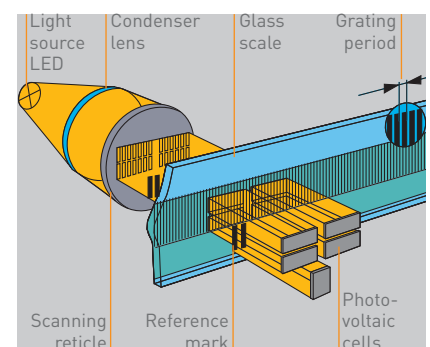
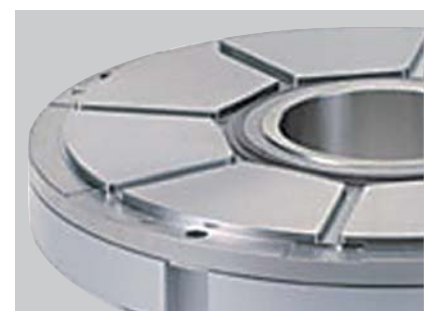

Precision

HSC core components: Thermal precision

Thermal precision

Cooling concept

The MIKRON HSM LP series ushers in a new era of precision cutting. Since high axis feeds over long periods always heat the drive assemblies, the MIKRON HSM LP series beats the problem with an ingenious cooling management system. Each of the linear axis as well as the circular swivel unit have their own cooling cycles. The heat is therefore systematically led out of the machine instead of being distributed inside it. This safe-

guards geometric stability, which in turn ensures extremely high motion control repeatability.

All electrical heat sources in the MIKRON HSM LP machines are water-cooled.

- X, Y, Z, B, C drives
- Tool spindle with Opticool technology
- Electrical cabinet



Five separate cooling circuits

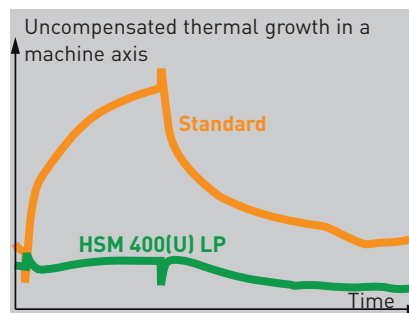

Liquid cooled primary and secondary drive

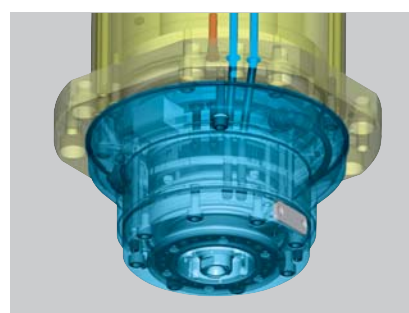

Tool spindle

Even greater precision with Step-Tec Opticool technology

- Cooling of the front roller bearings
- Low thermal flow in the tool interface
- Increases accuracy when working with the measuring probe on the machine

Measuring probe

Even greater precision with new Thermo-Lock measuring probe technology.

- Easy set-up
- Inhibits thermal flow between measuring probe and tool spindle
- Increases accuracy when working with the measuring probe on the machine
- Two strong partners: Thermo-Lock and Opticool

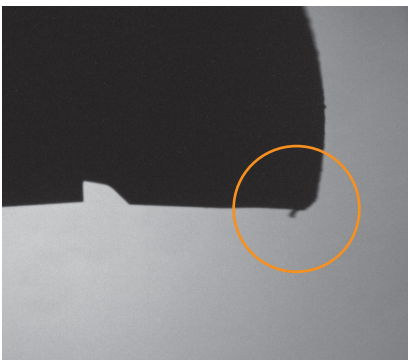
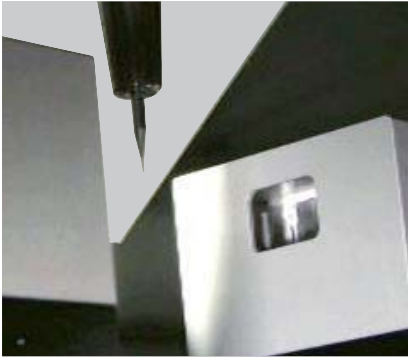

Detection of foreign particles

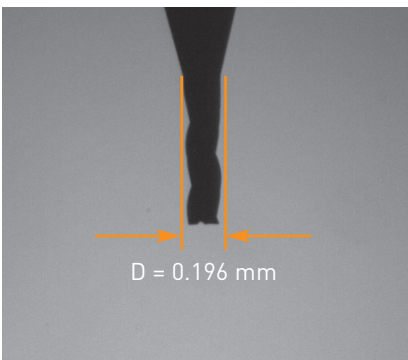

Measurement of smallest tool diameters

ITM (Intelligent Tool Measurement)

ITM tool measurement registers the entire tool tip up to \varnothing 12 mm on modern imaging sensors. Special software digitally cleans and measures the digitally captured tool geometry. An idea takes concrete shape: For the first time, ITM makes it possible to measure tools on a MIKRON machine with micrometer-range repeatability.

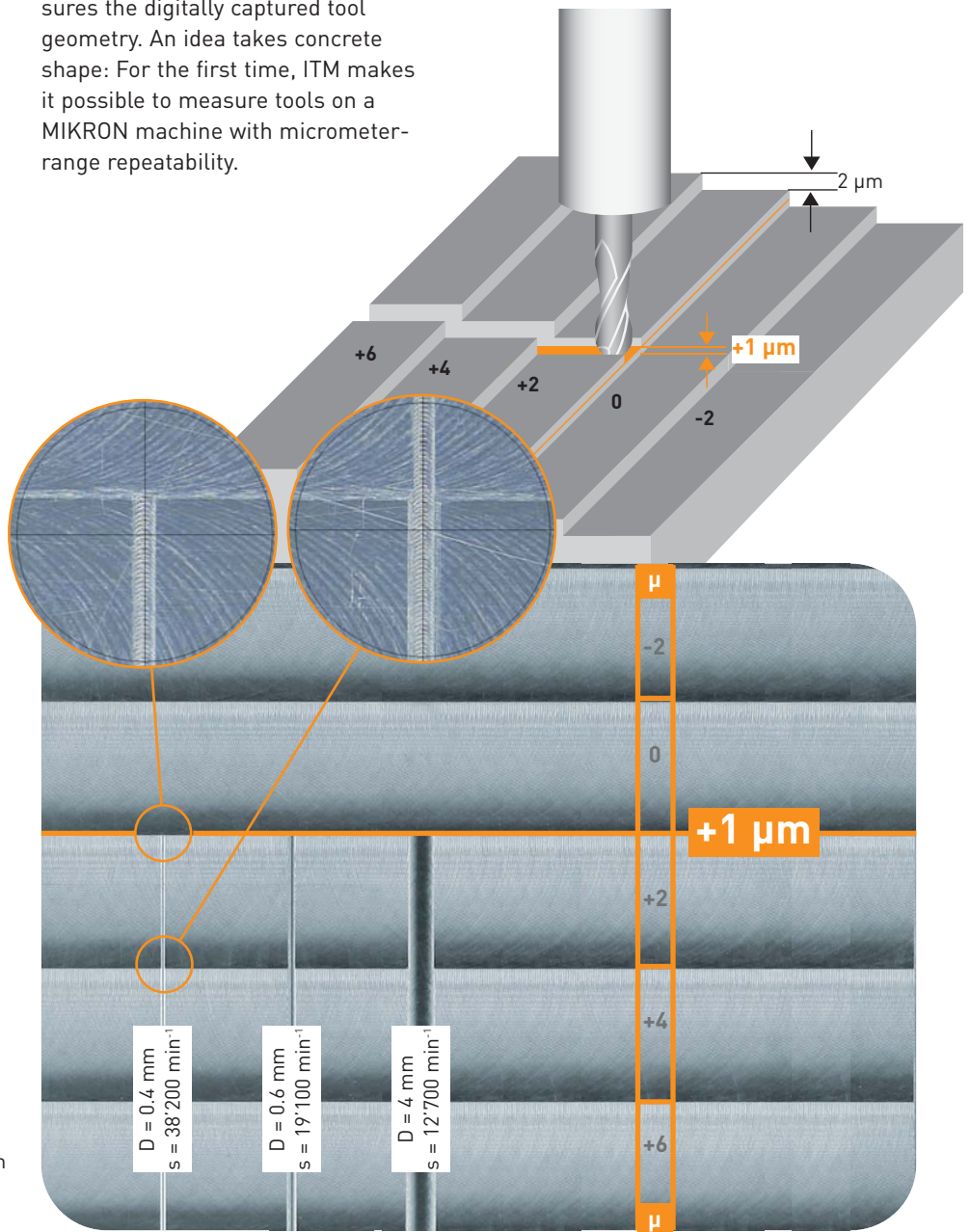

Test-piece with continuously increasing Z-level.

Step to step: $2 \mu\text{m}$
 Orthogonal cutting to zero point Z-level with intermittent measuring cycle of employed spherical cutting tool.



Achieve more...

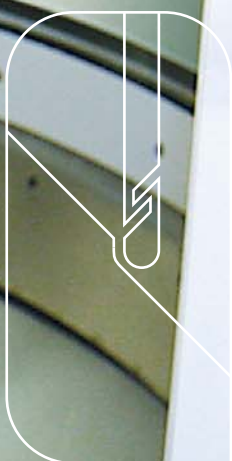

MIKRON HSM
400 LP, 400U LP, 500 LP
600 LP, 600U LP, 800 LP



Automation

Disc type or linear type magazines - more parts in shorter time at lower cost

3 axis versions

Machine tool size
Travel X, Y, Z: 500 x 450 x 360 mm

MIKRON HSM 400 LP 90 kg

System 3R GPS
240 x 240 mm

10x

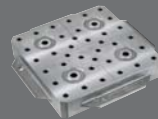

System 3R Dynafix
280 x 280 mm

7x

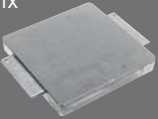

System 3R Dynafix
350 x 350 mm

7x



Erowa UCP
320 x 320 mm

7x

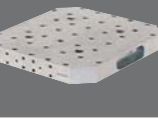

Machine tool size
Travel X, Y, Z: 600/800x600x500 mm

MIKRON HSM 600 LP 500 kg

GF AgieCharmilles
600 x 600 mm

4x

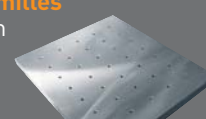

MIKRON HSM 800 LP 800 kg

GF AgieCharmilles
800 x 600 mm

4x

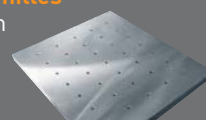

5 axis versions

MIKRON HSM 400U LP 25 kg

System 3R Macro Magnum
Ø 156 mm

18x

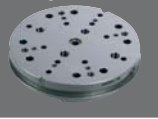

Erowa ITS
Ø 148 mm

20x

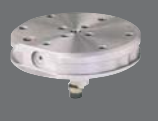

MIKRON HSM 600U LP 90 kg

System 3R GPS
240 x 240 mm

10x

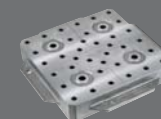

System 3R Dynafix
280 x 280 mm

7x

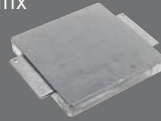

System 3R Dynafix
350 x 350 mm

7x



Erowa UCP
320 x 320 mm

7x

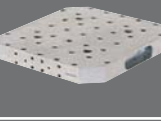

Pallet magazine is a major plus

GF AgieCharmilles has developed its own compact pallet magazines with customer requirements in mind. The disc and linear magazines can be loaded during operation and the CNC control is very easy to operate.

Disc type magazine

MIKRON HSM 400
MIKRON HSM 400U

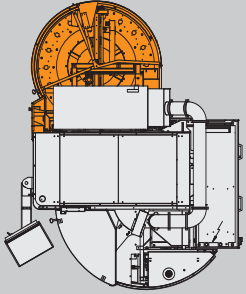

MIKRON HSM 600U

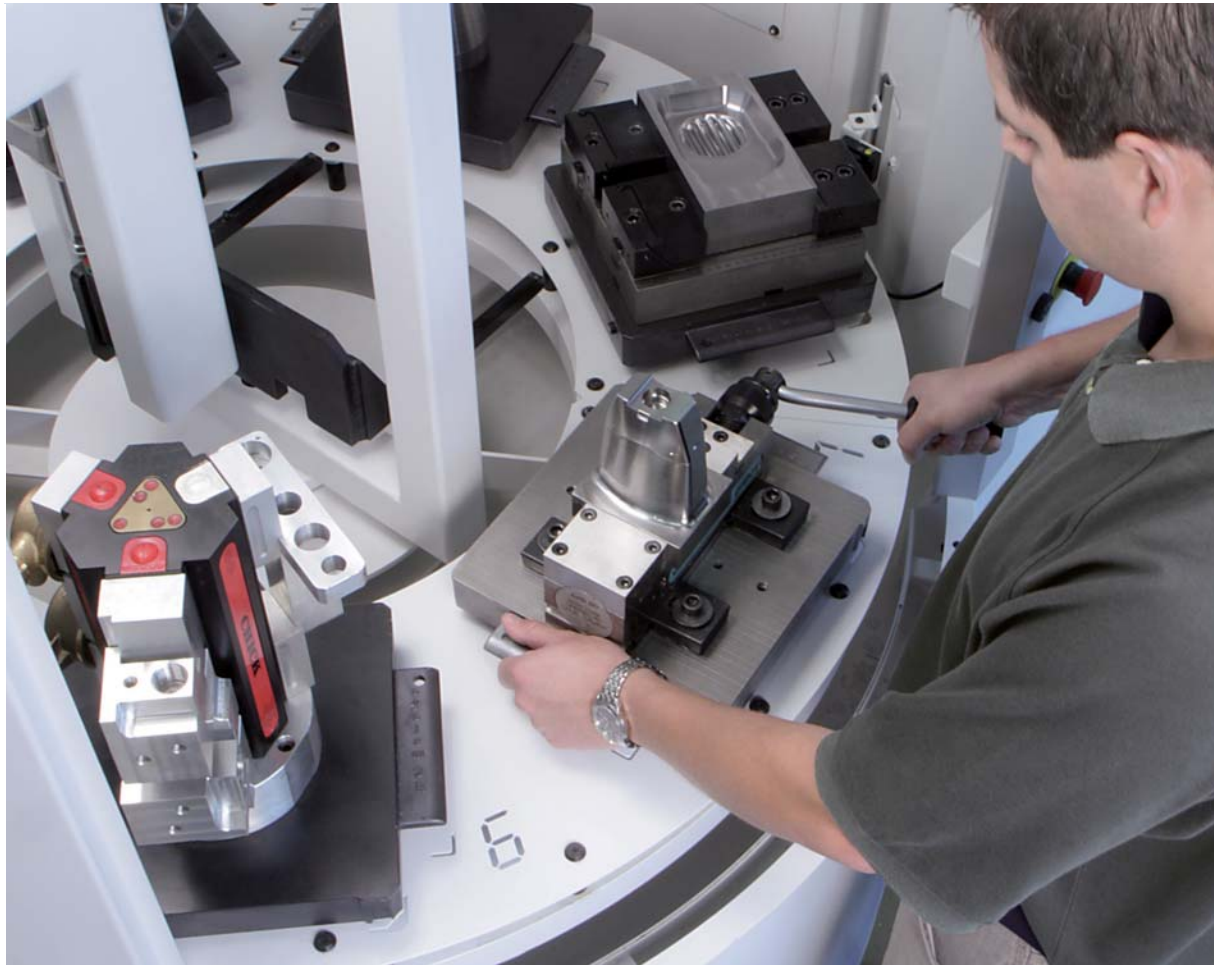
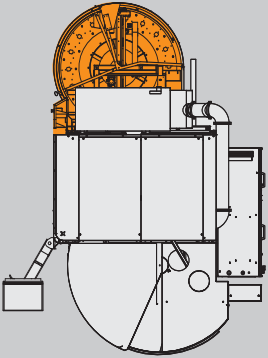

Linear type magazine

MIKRON HSM 600
MIKRON HSM 800

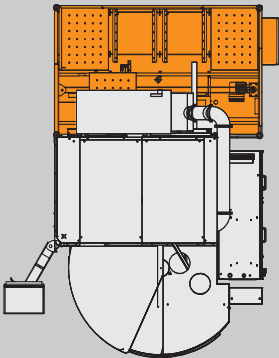

Ergonomic loading of
the disc and linear type
magazine during work
preparation

Interface for automation systems

Customer specific solutions -
more parts in shorter time at lower cost.



Automation interface (closed)

Automation interface (open)



A standardised robot interface allows the MIKRON HSM LP series to be operated with robot systems from reputable providers.

Regardless of the handling system used, the accessibility of the machine remains outstanding even when networking with other machines.

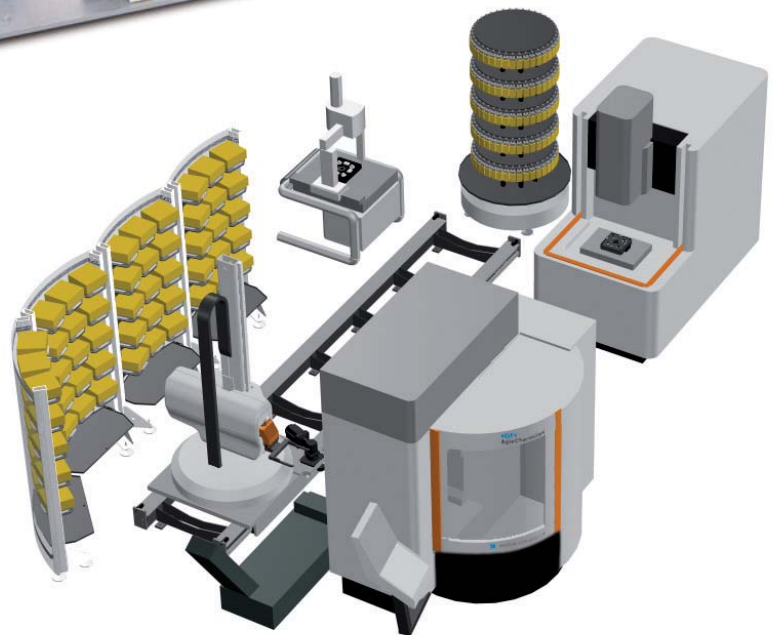

Limitless possibilities.

Loading and unloading takes place from behind through the portal.



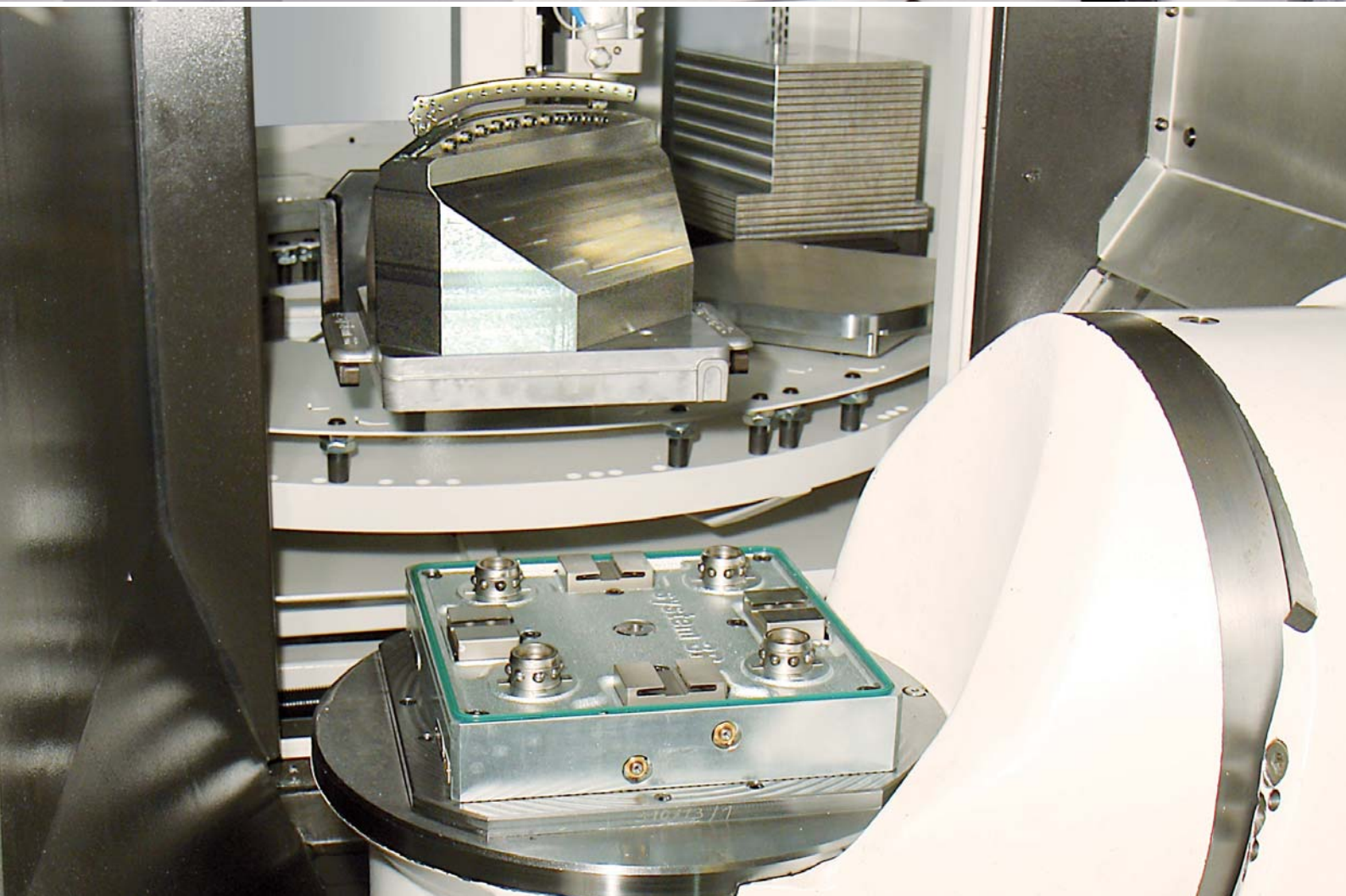
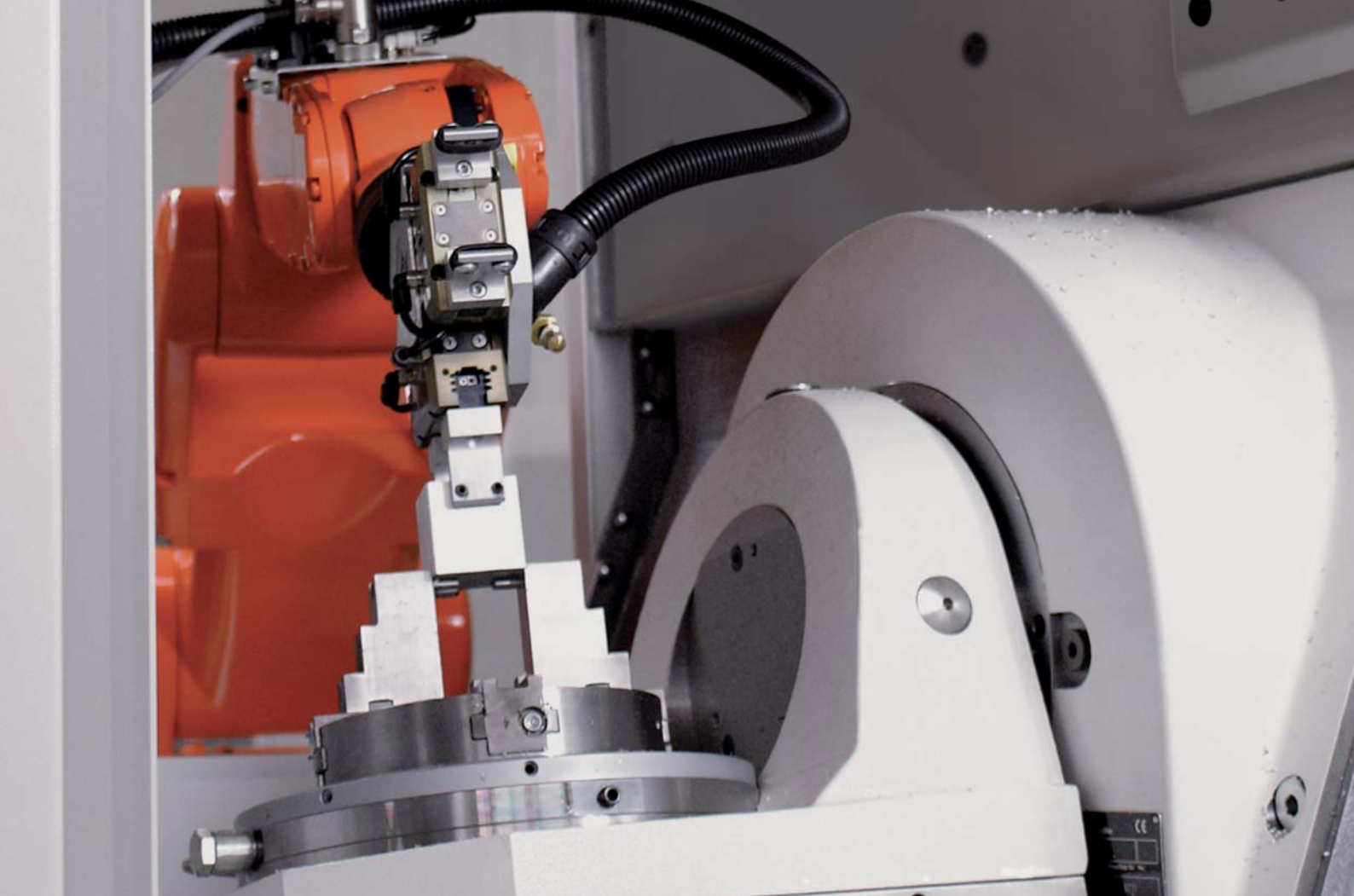

High-tech motor spindle

HSC core components from Step-Tec

Tool spindles for challenging machining tasks

Whatever machine configuration you choose, a MIKRON HSM LP machine gives you state-of-the-art tool spindle technology.

The facts

- Vector control for full torque in the lowest range
- Ultra-stable ceramic hybrid spindle bearings
- Spindle mantle cooling by means of a controlled coolant cycle for constant temperatures throughout working times
- Oil-air lubrication system with suction disposal of used oil
- Integrated "smart machine" sensors
- Cooling between tool interface and frontal spindle bearings in the Opticool spindles

You benefit from

- Precise high-performance
- Shorter acceleration phases
- High torque
- Thread cutting without compensation chuck

	Opticool	Opticool	Opticool	Opticool
	30'000 min ⁻¹ HSK-E40	36'000 min ⁻¹ HSK-E50	42'000 min ⁻¹ HSK-E40	54'000 min ⁻¹ HSK-E32
HSM 400 LP	•		•	•
HSM 400U LP	•		•	•
HSM 500 LP	•		•	•
HSM 600 LP	•	•	•	
HSM 600U LP	•	•	•	
HSM 800 LP	•	•	•	



Step-Tec has developed, produced, sold and repaired precision high-performance spindles for leading manufacturers of machining centers for milling and drilling applications since 1995.



The delivered package includes the smart-machine module APS (Advanced Processing System) for reliable detection and display of vibrations during the milling process.

Tool automation in every configuration level

- Simple or double-row disc magazine
- Reliable "pick-up" changing system
- Feed control via light beam
- Capacity of up to 68 tools with magazines internal to the machines standard footprint
- Orientation of the touch probe

Optionally available in a variety of capacities:

MIKRON HSM 400 LP	MIKRON HSM 600 LP
MIKRON HSM 400U LP	MIKRON HSM 600U LP
MIKRON HSM 500 LP	MIKRON HSM 800 LP
HSK-E40 : 18; 36; 68 tools	HSK-E50 : 15, 30, 60 tools
HSK-E32 : 20; 40 tools	HSK-E40 : 18; 36; 68 tools



Double-row HSK-E40 magazine internal to the machines standard footprint with a capacity of 68 tools



User-friendly tool feeding

Productivity and process reliability are ensured by lateral tool feeding

- Simultaneous machining and feeding
- Simple feed monitoring through large glass panel
- Ergonomic access

Chip and Dust management

Clean workspace

Vacuum removal of graphite

Equipment versions

Chip forms and volumes are determined by the work material and the machining strategy. The options offered range from an emulsion coolant tank with chip flushing to versions with cutting oil and coolant temperature stabilisation ...

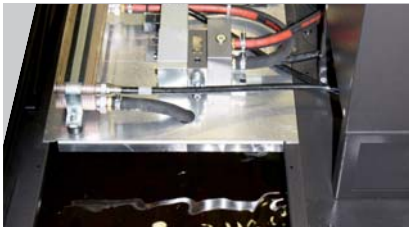

or with a lift-up chip conveyor with chip auger.

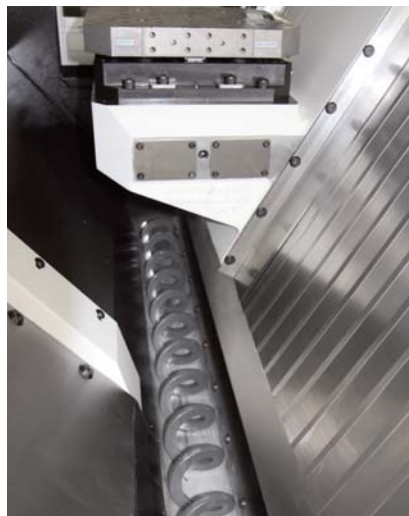

To increase the tank capacity an external filter system of 650 l is also available.

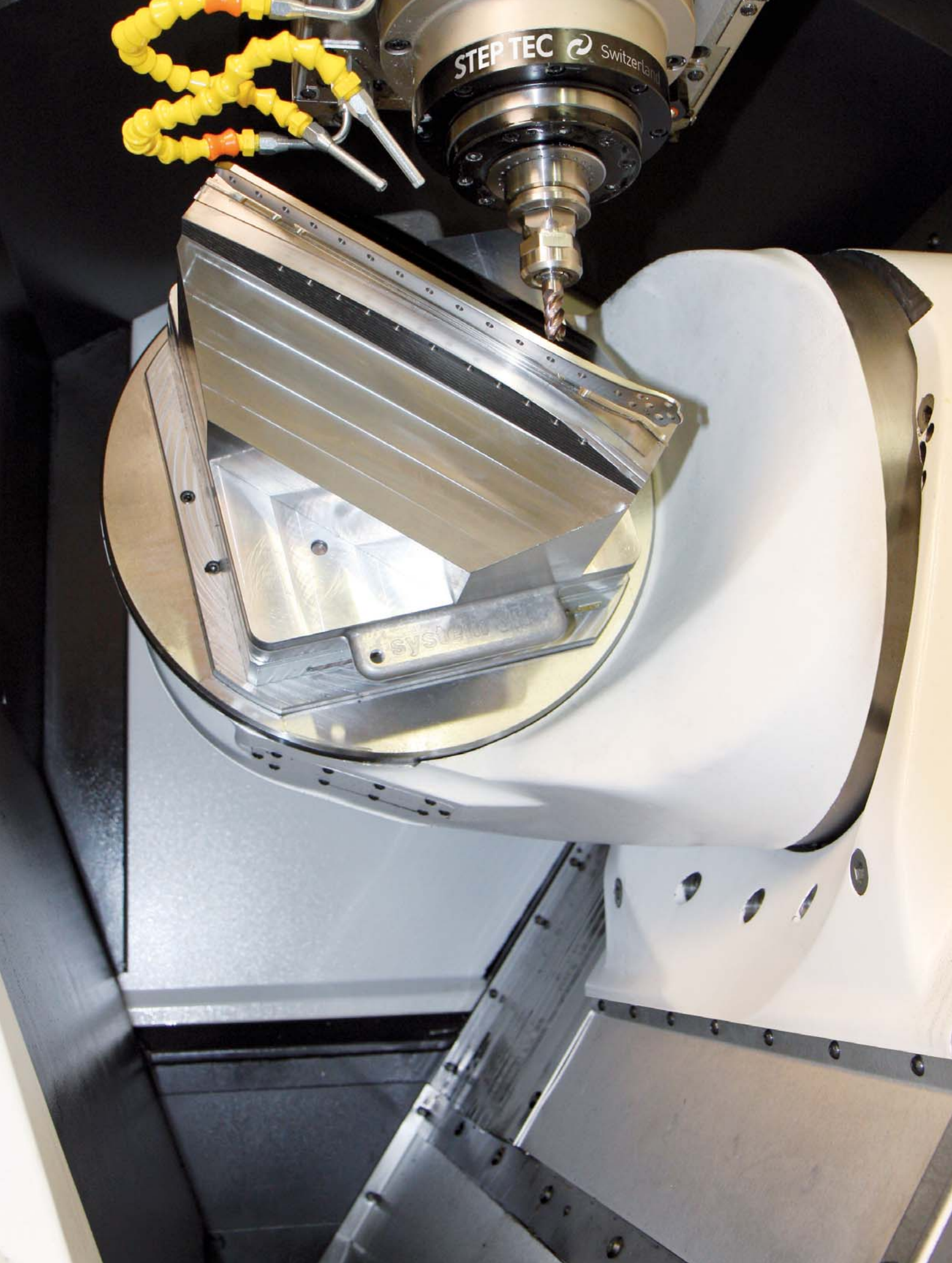

Option: ProdMod

Automated parts production: 24/7

Built to withstand tough production conditions

Thanks to its flexibility and reliability the MIKRON HSM ProdMod product series is a benchmark for automated production of high quality parts.

- Efficient management of chips
- A flushing system reliably keeps the workspace doors free of chips.
- Feed of coolant through the center of the spindle
- Extended tool-storage capacities
E40 (168x or 308x)
E50 (120x, 170x, 220x)
- Integrated laser tool measuring system



Air blast through the spindle center and/or Through spindle coolant (TSC)

With TSC up to 70 bar can bring the cooling lubricant with high pressure and process reliability to the cutting edges of the tool. Differing tool diameters do not require new alignment of the coolant hoses. The purity of the lubricant effects the life time of the spindle. A filter system is therefore essential.



Extended tool magazine

The tool storage device external to the machines standard foot-print is built as a circular hanger with up to 308 tool positions.
Time for changing tools: < 2 sec.
Time for preparing tools: < 10 sec.



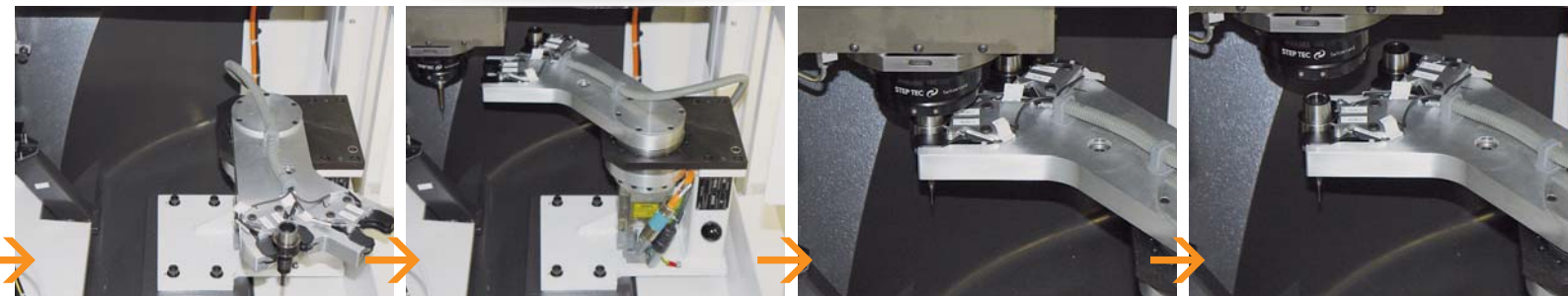

Options

Tailor-made equipment



Chip flushing



Cooling lubricant container

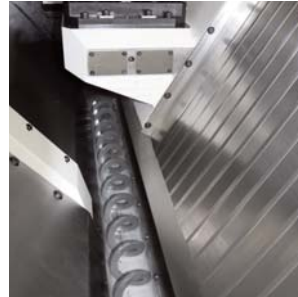

Spiral chip conveyor



Lift-up chip conveyor



High performance band filter unit

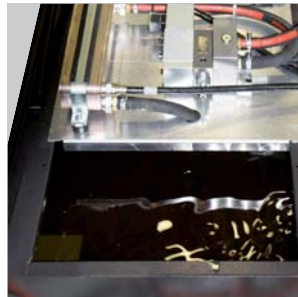

Cutting oil package with temperature stabilisation



Minimum quantity lubrication



Mist extraction system



Mist extraction system



Automation interface (closed)

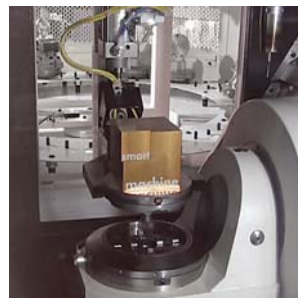

Automation interface (open)



Touch probe TI



smart machine
(www.gfac.com)

Further options:

- Rotating window
- Dust extraction system
- Beacon
- Laser tool measurement
- ITM (Intelligent Tool Measurement)
- ...

smart machine

The new dimension in modern production

Bringing intelligence into the milling process is the intended aim of "smart machine".

This includes a range of modules that are collectively referred to under the generic term "smart machine" and that fulfil various functions. In order to make the milling process "intelligent", various requirements have to be implemented.

First of all, establishing comprehensive communication between man and machine, which makes precise information that the operator requires to assess the milling process available to him. Secondly, supporting the operator in the optimisation of the process, which considerably improves the performance. Thirdly, the machine optimises the milling process, which improves the process safety and the quality of the workpiece - above all in unmanned operation.

The facts

- Greater accuracy in shorter machining times
- Increase in the workpiece surface quality as well as the surface and shape accuracy
- Recognition of critical machining strategies
- Improvement in the process safety
- Reduction of the machine set due to longer service life
- Higher availability
- Better operating comfort
- Considerable increase in reliability in unmanned operation

smart machine construction kit system

Each of the modules fulfils a specific task. Just like in a construction kit, the user can select the modules that seem to him to be the best option for improving his process.

Your benefit

Producing the workpieces in a process-secure and precise manner, increasing the reliability in unmanned operation, increasing the service life of the machine and significantly reducing production costs.



Protection

- APS
- SPS
- CAM plate
- PFP

Precision

- ITC
- ITC 5X
- OSS
- OSS

Productivity

- OSS
- OSS
- CAM plate
- SIGMA FMC
- RNS

The smart machine is constantly being further developed.

The currently available modules can be found at www.gfac.com

About GF AgieCharmilles

Milling

High-Speed and High-Performance Milling Centers

In terms of cutting speed, HSM centers are 10 times faster than conventional milling machines. Greater accuracy and a better surface finish are also achieved. This means that even tempered materials can be machined to a condition where they are largely ready to use. One essential advantage of HSM is that with systematic integration, the process chain can be significantly shortened. HSM has developed alongside EDM into one of the key technologies in mold and tool making.

EDM

Electric Discharge Machines

EDM can be used to machine conductive materials of any hardness (for example steel or titanium) to an accuracy of up to one-thousandth of a millimeter with no mechanical action. By virtue of these properties, EDM is one of the key technologies in mold and tool making. There are two distinct processes – wire-cutting EDM and die-sinking EDM.

Laser

Laser ablation

Laser ablation supplements and extends the technologies offered by GF AgieCharmilles. With our laser technology we enable you to produce texturizing, engraving, microstructuring, marking and labeling of 2D geometries right through to complex 3D geometries. Laser ablation, compared to conventional surface treatment using manual etching processes, offers economic, ecological and design advantages.

Customer Services

Operations, Machine and Business Support

Customer Services provides with three levels of support all kind of services for GF AgieCharmilles machines.

Operations Support offers the complete range of original wear parts and certified consumables including wires, filters, electrodes, resin and many other materials.

Machine Support contains all services connected with spare parts, technical support and preventive services.

Business Support offers business solutions tailored to the customer's specific needs.

Automation

Tooling, Automation, Software

Tooling for fixing workpieces and tools; automation systems and system software for configuring machine tools and recording and exchanging data with the various system components.

Contact

www.gfac.com

+GF+

AgieCharmilles

© Agie Charmilles SA, 2011
The technical data and illustrations are not binding.
They are not warranted characteristics and are subject to change.

Achieve more...