

AgieCharmilles

# LASER P 600/1000/1200/4000 U



### GF Machining Solutions: all about you

When all you need is everything, it's good to know that there is one company that you can count on to deliver complete solutions and services. From world-class electrical discharge machines (EDM), Laser texturing and Additive Manufacturing through to first-class Milling and Spindles, Tooling, Automation and software systems — all backed by unrivalled customer service and support — we, through our AgieCharmilles, Microlution, Mikron Mill, Liechti, Step-Tec and System 3R technologies, help you raise your game and increase your competitive edge.



# Passion for Precision

# Contents

- We are 4
- Laser texturing 5
- Versatile texturing solution 6
- Industry 4.0 7
- Electronic consumers 8
- Packaging 9
- Automotive 10
- Ease of use 12
- Higher degree of autonomy 14
- Act responsibly 16
- GF Machining Solutions 18



**Experience our laser texturing solutions**  
GF Machining Solutions' full range of Laser texturing expertise helps you make your distinctive marks. Forward-thinking manufacturers recognize the benefits of GF Machining Solutions' Laser technology using high-powered ytterbium pulsed fiber lasers with a fine beam diameter down to 30 µm.

We are

# The reference for mold and die solutions

## **Years of proven expertise**

GF Machining Solutions has long been recognized as the market leader for mold and die solutions. Laser texturing was developed to provide efficient and outstanding texturing results. We provide new product design possibilities and superior technical support for the mold and die manufacturers around the world.

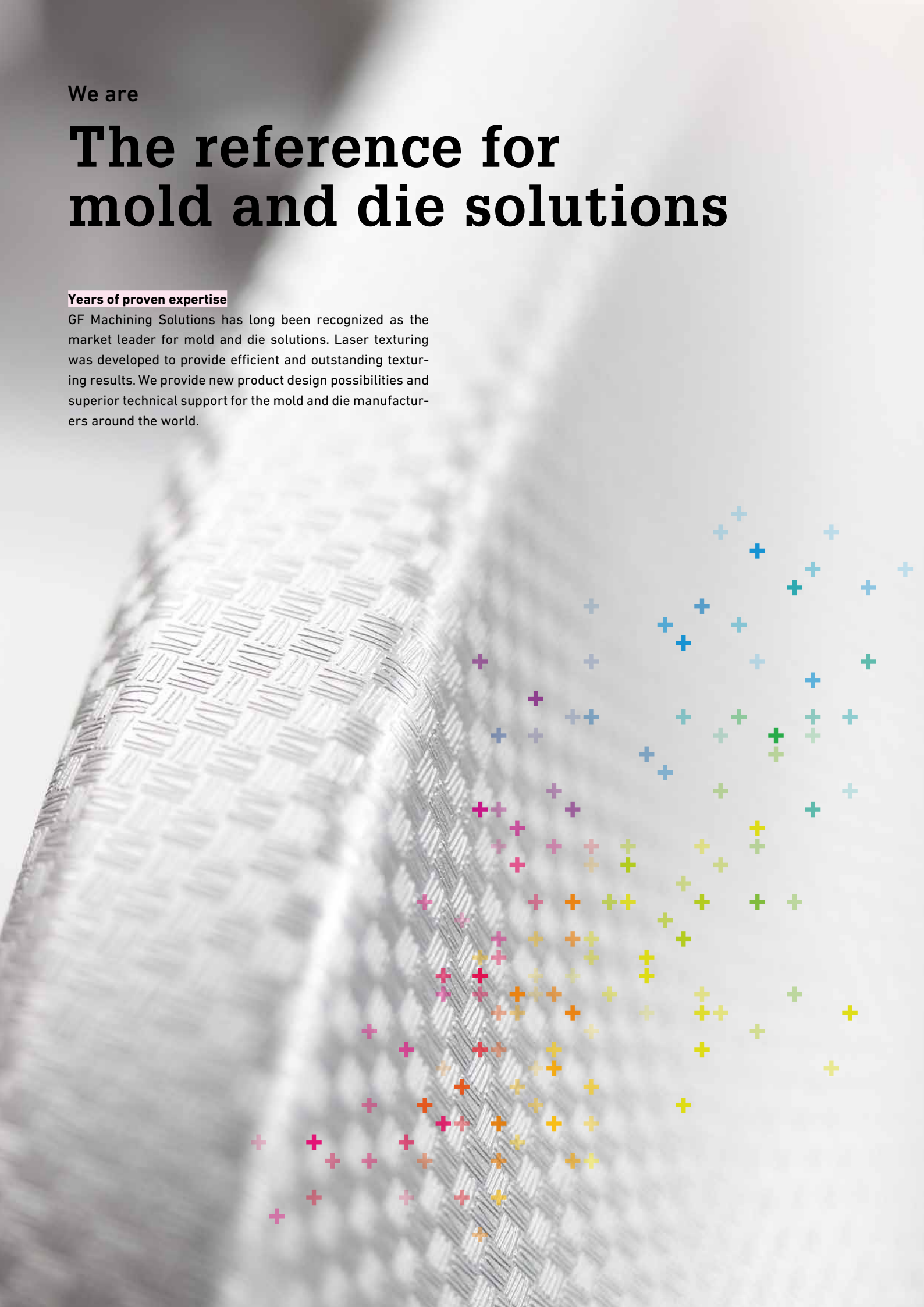

## Laser texturing

# Brings the future to you

GF Machining Solutions' high-precision Laser texturing solutions allows you to easily with infinite repeatability make your distinct mark on 3D geometries in a wide range of industries. These industries include automotive, consumer electronics, packaging, tooling, mold making, and lifestyle/consumer products (shoes, sporting products, and luxury goods).



**+ New Look**  
New HMI controller  
for better ease of use

**+ Comfortable**  
Work free maintenance; no calibration  
or power control necessary to achieve  
stunning results

**+ Powerful**  
GF Machining Solutions' software  
package comes standard —  
a unique/powerful tool for  
achieving incomparable results

### **A wide variety of material**

Laser machines easily texture a wide variety of materials. This includes steel, aluminum, carbide, brass, graphite, copper and ceramics. Our unparalleled machine fleet, design, support, automation solutions, and Customer Services, are all things to trigger your experience to excellence.

### **Total freedom of design**

The advantages of using a process 100% digitized combined with our products are undeniably impressive. What you see is what you get, and achieve perfect repeatability, without limits on design or quality.

Versatile texturing solution

# Supporting designers' creativity

Using digital technology for design minimizes the risk of deviation from your original idea. You can think and create with no limitations.

## **Expert support for your creative process**

Our Laser texturing process starts with a digital bit-map/grayscale file created in-house or from a natural surface by reverse engineering via 3D scanner. Our software eliminates the guesswork, allowing our Laser products to recreate your distinct designs on large and complex surfaces with expected results.





# Enhancing your manufacturing process

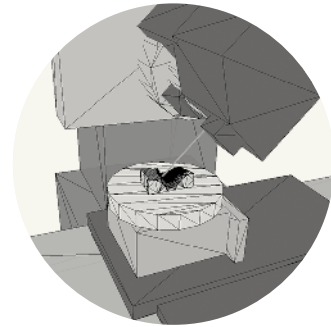

## Higher detail and contrast reproduction

Laser texturing combined with a heat and cool molding process opens even more design possibilities. The heat and cool process allows you to achieve high-gloss surfaces, achieve high-quality reproduction of Laser textures, increase contrasts between surfaces, and improve your texture visibility.

## Fully digitized process for infinite repeatability

GF Machining Solutions' Laser technology uses a fully digital process for five axis texturing and engraving. Our smart mapping solution manages random and overlapped textures to provide continuity of your design when it is applied to the end product.

## Fast, accurate surface calculation

Fast, accurate and easy surface calculation is built into our Laser solutions, saving you time and increasing your productivity.

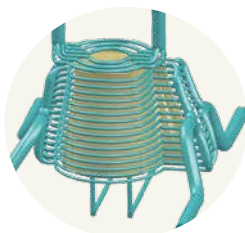
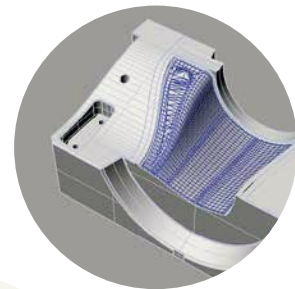

Electronic consumers

# Data manufacturing

Listening to your needs, GF Machining Solutions offers multiples possibilities in the ICT world. Up to the finest details, GF Machining Solutions' Laser technology allows you to fulfill the needs of the ICT industry. From mobile phones to laptops and many other applications, our years of experience in these fields makes us the reference for globally renowned brands.

## Texture small cavities

Don't let manufacturing methods associated with miniaturization slow your creativity. With Laser texturing, you can texture product areas that standard chemical techniques cannot and even achieve, and also provide the desired accuracy on 3D shapes.





## Packaging

# Optimize and simplify your process

Productivity, quality, and product differentiation are three key success factors in today's fast-moving global Marketplace. Particularly in the packaging sector, where mold makers and designers are looking for new manufacturing and design possibilities. As a long-time, expert partner to packaging manufacturers worldwide, we are the single-source provider of the solutions you need today.

### Optimize lead times with quality

The design of most plastic food containers incorporates contrasts between glossy and/or matte surfaces. With our solution simply and precisely generates a blasting effect, eliminating the need for insert polishing and human intervention.

### Control risk of outsourcing

Texturing of PET and glass bottles is usually done with traditional methods involving acid and humans. Laser texturing overcomes these difficulties by introducing a perfectly stable and repeatable process to the manufacturing chain. Experience new product design possibilities while controlling quality over your manufacturing chain.

### Simplify processes

Our Laser technology optimizes your time by making your process simpler and our Automation solutions increase your productivity.



## Automotive

# Innovation in motion

GF Machining Solutions' Laser texturing technology is poised to revolutionize functional surface texturing. Moreover, our Laser technology is a clean, sustainable solution for applications like the distinct aesthetic texturing of molds for automotive tires, lighting modules, interiors and more.

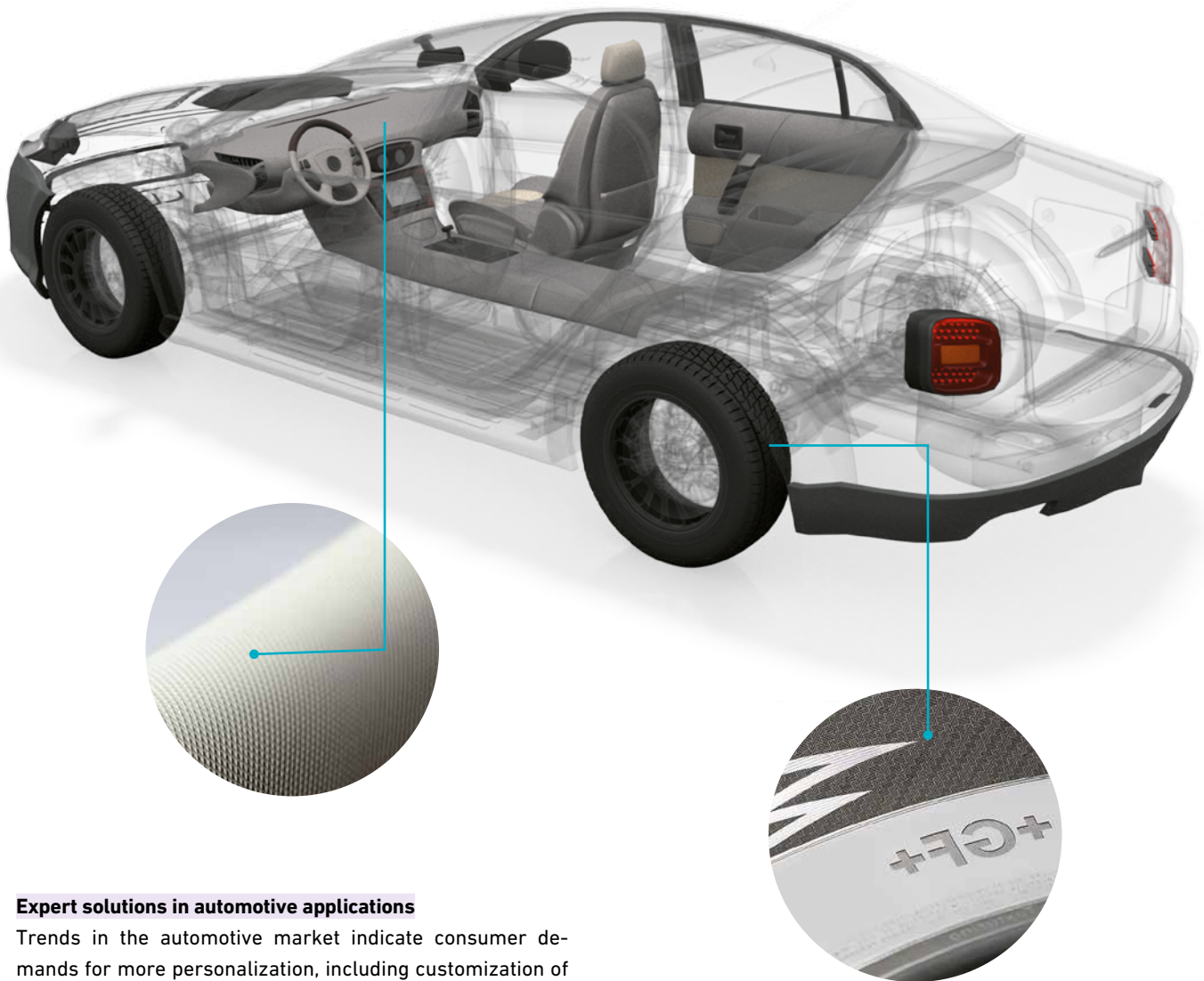

### Expert solutions in automotive applications

Trends in the automotive market indicate consumer demands for more personalization, including customization of car exteriors and interiors while geometrical textures in automotive interiors are more and more popular in this sector. Laser texturing machines from GF Machining Solutions help manufacturers to fulfill these demands, guaranteeing quality, repeatability, and continuity between arts. That's the plus of working with the market reference in mold texturing.

### Increase your brand's visibility

Logos on molds for tire sidewalls are crucial in the tire industry. By increasing contrasts, Laser texturing raises the visibility of your brand and ramps up the perceived value of your product. Increase your visibility by 50 percent.

## Automotive

# Control quality with digital technology

### Minimize risks by boosting quality and time to market

Previously subcontracted, matte surfaces on car lighting elements are feasible in your own workshop right after milling and polishing while eliminating the risk of human errors compromising your mold quality. Our Laser texturing automatically reproduces a sand blasting effect. Benefit from the advantages of a digital technology: no human errors, 100 percent repeatability of your sand blasting effect, perfect reproduction of your own texture and mark. With GF Machining Solutions, you master your process by doing it all in-house.

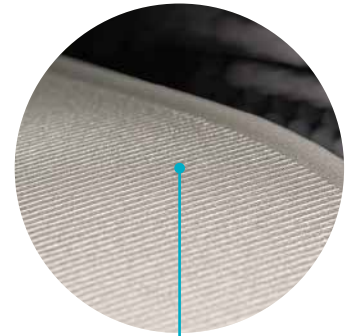

### Optimize light diffusion

New-generation car lighting has lenses with surface texture to optimize light diffusion. Laser technology helps you guarantee homogenous light coverage to improve quality and guarantee safe driving.

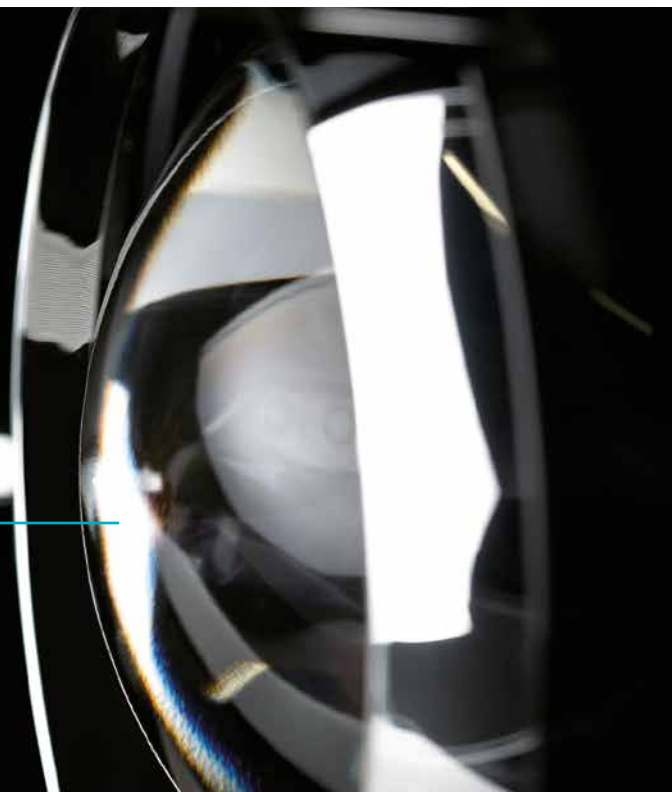
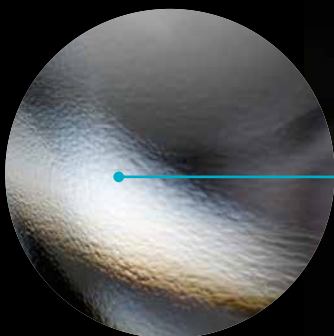



Ease of use

# Designed for users

GF Machining Solutions optimizes your ease of use. Whatever your application needs, we have a solution to drive your success.

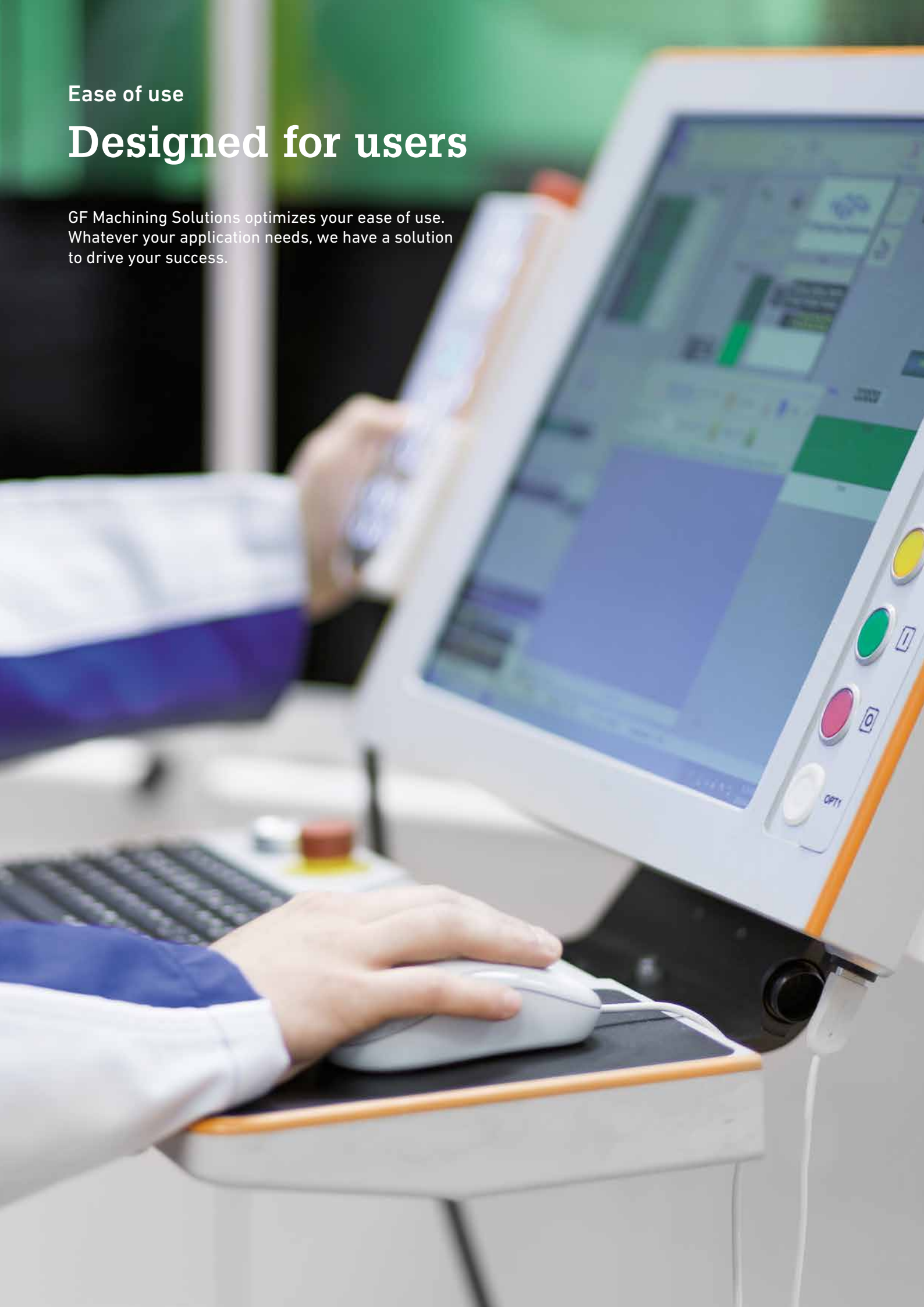



### **You choose the lens you need**

Our Laser solution allows you to select the specific lens needed to realize your particular application (with f-Theta from 100 up to 420 mm).



### **Accurate and fast positioning measurement**

All in one, our unique Laser head guarantees high positioning accuracy and fast, accurate tool measurement. Work accurately with one Laser head set as standard.



### **A wide range of laser source**

Starting from 20 W for high demand quality applications to 30 W, 50 W or 100 W for efficient laser machining, we know exactly the solution matching your application for the best costs performances ratio.

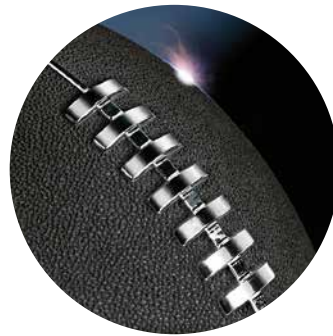

### **The most powerful software package**

Developed by GF Machining Solutions, the all-in-one dedicated software package allows you to master your job from the preparation phase and, graphic design all the way through to, transition-free patching and, UV mapping for applying texture and 3D simulation. Our all-in-one package delivers machining results aligned with your expectations.

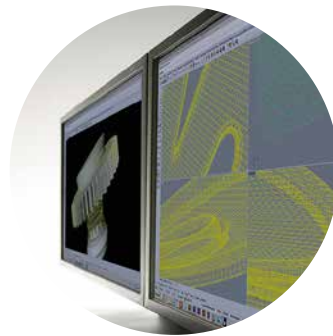



Higher degree of autonomy

# Increase your productivity

Experience always shows that measures to reduce the idle times of your machines are significantly more worthwhile than chasing seconds in the actual machining process. The solution is a stable and exact reference system. This lets you preset away from the machine and then set up the machine with minimum idle time, quickly and precisely with System 3R tooling, part of GF Machining Solutions.

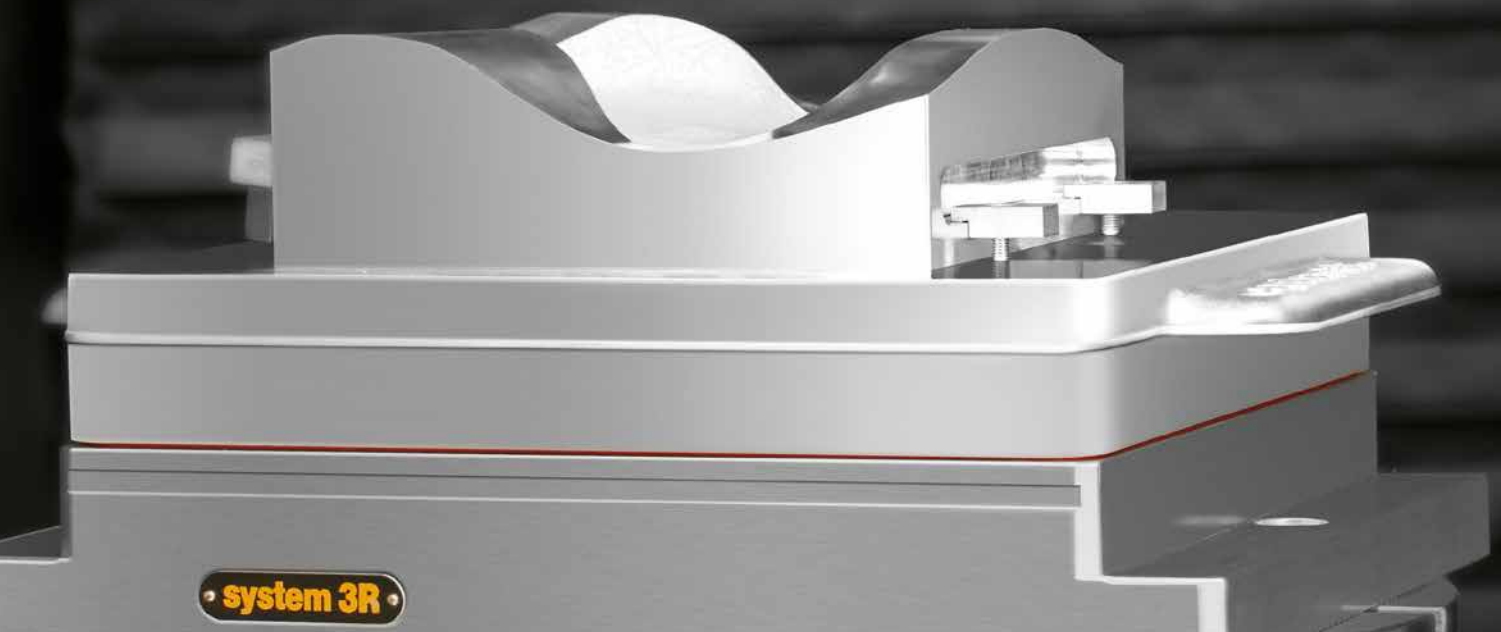

## One partner to optimize your productivity

We deliver a large range of tooling to match your application and reduce unproductive times on your machine.

Tooling		LASER P 600 U	LASER P 1000 U	LASER P 1200 U	LASER P 4000 U
Macro	54/70/Ø75/Ø116	X			
GPS 120	Ø120	X			
MacroMagnum	Ø156	X	X		
GPS 240	240/300	X	X	X	
Dynafix	280/350		X	X	
Delphin	410 – 500			X	
Delphin	510 – 700			X	
Specific				X	X

Higher degree of autonomy

# Add flexibility

Flexibility, including solutions that can accommodate production changes to match your business and environment, is a key success factor in today's marketplace. To make your machines more flexible in handling workpieces of various sizes, various chuck adapters are available for all of our tooling systems.

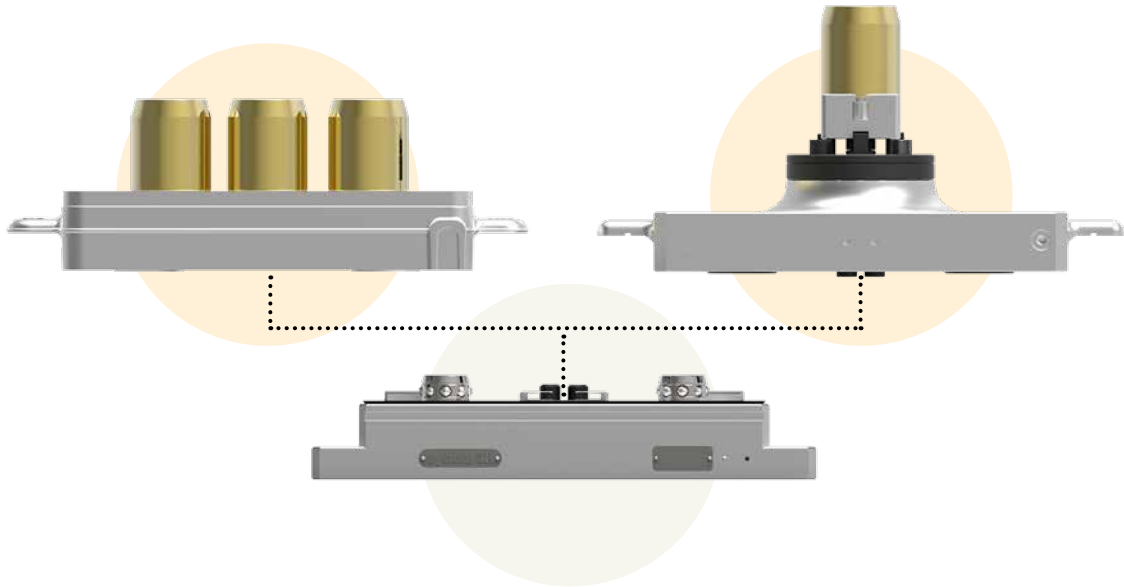

## Boost your competitiveness

Automation keeps production going whatever the time of day or day of the week. You achieve shorter lead times, higher productivity and quicker payback of capital invested in machines. With automated operations, production can continue running around the clock, seven days a week. Possibilities are endless.



Act responsibly

# Produce with more respect and less impact

Environmental sustainability is a major issue today and beyond, and GF Machining Solutions is committed to reducing impacts on the environment. Our Laser texturing technology plays a major role in producing textured products in a cleaner, more efficient way.

## **Reduced impact compared to traditional texturing methods**

Laser texturing reduces the need for traditional methods that pollute the environment and limit your design potential. Our clean, non-polluting Laser technology allows you to texture in-house and, as a digital process, it is perfectly aligned with Industry 4.0.

## **Save energy**

Requiring no oil or consumables, our Laser texturing solution is one of the market's lowest energy consumers, allowing you to save money and contribute to environmental sustainability.





## Technical specifications



**LASER P 600 U**



**LASER P 4000 U**

		<b>LASER P 600 U</b>	<b>LASER P 1000 U</b>	<b>LASER P 1200 U</b>	<b>LASER P 4000 U</b>
<b>Machine</b>					
Ytterbium pulsed fibre laser	W	20/30/50/100	20/30/50/100	50/100	50/100
Focal length	mm	100/160/254	100/160/254	100/160/254	330/420
	in	3.9/6.3/10	3.9/6.3/10	3.9/6.3/10	6.3/10/12.3/16.5
Machine dimensions *	mm	2050 x 2280 x 2770	2240 x 2605 x 2845	2240 x 3395 x 2930	7000 x 10000 x 5250
	in	80.7 x 89.8 x 109	88.2 x 102.6 x 112	88.2 x 133.7 x 115.3	275.6 x 393.7 x 206.7
Approx machine weight	kg	5000	6500	8700	32000
	lbs	11023	14330	19180	70548
Max. power consumption	kW	4	4	4	12.5
<b>Axes</b>					
X,Y, Z travels	mm	600 x 460 x 830	1000 x 550 x 880	1200 x 900 x 1200	4000 x 3000 x 1500
	in	23.6 x 18.1 x 32.7	39.4 x 21.6 x 34.6	47.2 x 35.4 x 47.2	157.5 x 118.1 x 59
Laser titling axis A	°/s, °	180, 210	180, 210	180, 210	180, 270
B axis max. speed	°/s, °	180	180	90	180, 370
B axis table diameter	mm	180	380	800	-
	in	7.08	15	31.5	-
<b>Work area</b>					
Max 5 axis machining volume	mm	Ø 370 x 530 **	Ø 510 x 480	Ø 865 x 790	2800 x 1800 x 1170
	in	Ø 14.6 x 20.9 **	Ø 20.1 x 18.9	Ø 34.1 x 31.1	110.2 x 70.9 x 46.1
Max workpiece volume	mm	Ø 420 x 530	Ø 510 x 480	Ø 920 x 790	4000 x 3000 x 1170
	in	Ø 16.5 x 20.9	Ø 20.1 x 18.9	Ø 36.2 x 31.1	157.5 x 118.1 x 46.1
Max workpiece weight 5 axis	kg	75	150	1700	20000
	lbs	165	330	3748	44092

\* Width x depth x height \*\* FL160

# GF Machining Solutions



## EDM (electrical discharge machining)

**AgieCharmilles wire-cutting, die-sinking and hole-drilling machines**

For over 60 years we have been at the forefront of every EDM development: designing and refining the EDM process and building machine tools that deliver peerless part accuracies, surface finishes, cutting speeds and process reliability. Today, our AgieCharmilles wire-cutting, die-sinking and hole-drilling machines are recognized throughout the world as the best in the business. Our continuous research and development in digital generator technology, control systems and integrated Automation systems are evidence of our commitment to keeping your EDM operations on the leading edge of technology.



## Laser

**AgieCharmilles Laser texturing machines**

Laser texturing is a fully-digitized surface engineering process that has huge potential. The technology enables precise 2D and 3D textures or engravings to be machined accurately and directly onto complex parts or molds to improve and alter their aesthetic appeal, functionality and performance. The process is infinitely repeatable and offers many distinct environmental and economic advantages over conventional texturing processes.

**Laser Additive Manufacturing (AM)**

GF Machining Solutions has partnered with EOS, the global leader for high-end AM solutions, to integrate this innovative technology and further develop it into its current solutions to fully benefit the mold industry, by focusing on injection efficiency: optimized cooling design to reduce cycle time, lower energy consumption, higher quality of plastic parts.



## Tooling and Automation

**System 3R Tooling, Automation and software**

Productivity is the key to manufacturing success, and automating a manufacturing process is a proven method of increasing its efficiency, effectiveness, quality and reliability. System 3R's integrated Tooling, Automation and software solutions ranging from simple workpiece pallet and electrode changers through to flexible manufacturing and robot handling systems are guaranteed to help you increase their competitive advantage.



## Milling

**Mikron MILL S (high-speed Milling), Mikron MILL P (high-performance Milling) and Mikron MILL E (high-efficiency Milling)**

Customers operating in the mold, tool and die and precision component manufacturing sectors stake their reputations on being able to quickly and cost-competitively meet their customers' demands. That's why they invest in GF Mikron machines. Incorporating the latest and most advanced technologies and premium-performance components, Mikron MILL S, Mikron MILL P and Mikron MILL E machines help you increase your production capabilities and improve your productivity. Designed and built for speed, accuracy and reliability, the machines, like you, are proven performers.

**Liechti dedicated aerospace and energy machining centers**

Aerospace and power generation turbine manufacturers increasingly turn to Liechti dedicated five- and six-axis machining centers to machine complex, high-precision airfoils on blades, disks, blisks, blisks/IBRs and impellers. It's easy to see why because these machines, with their specific profile machining technology, specialized CAD/CAM software and engineering competence for ultra-dynamic machining in titanium, Inconel, nimonic, titanium-aluminide and high-alloy steels, yield productivity gains as much as 30 percent, thanks to reduced machining times. In the globally competitive aerospace and power generation manufacturing sector, that's definitely worth shouting about.

**Step-Tec Spindles**

At the heart of every GF Mikron machining center is high-performance Step-Tec Spindle. Step-Tec Spindles are essential core components of our machining centers. Highly accurate and thermally stable Step-Tec Spindles ensure that our machines can handle everything from heavy-duty roughing to fine-finishing operations.



## Customer Services

**Operations Support, Machine Support and Business Support**

To help you get the most and the best from your machine tools and equipment, we offer three levels of support. Operations Support covers our range of original wear parts and certified consumables (EDM wires, filters, resins, electrodes etc.) to ensure that your machines are performing at the highest levels. Machine Support maximizes, through our best-in-class technical support, preventive services and quality spare parts, your machine tool uptime. Business Support is designed to help you make a real step-change in your productivity and performance with solutions tailored to your specific needs.

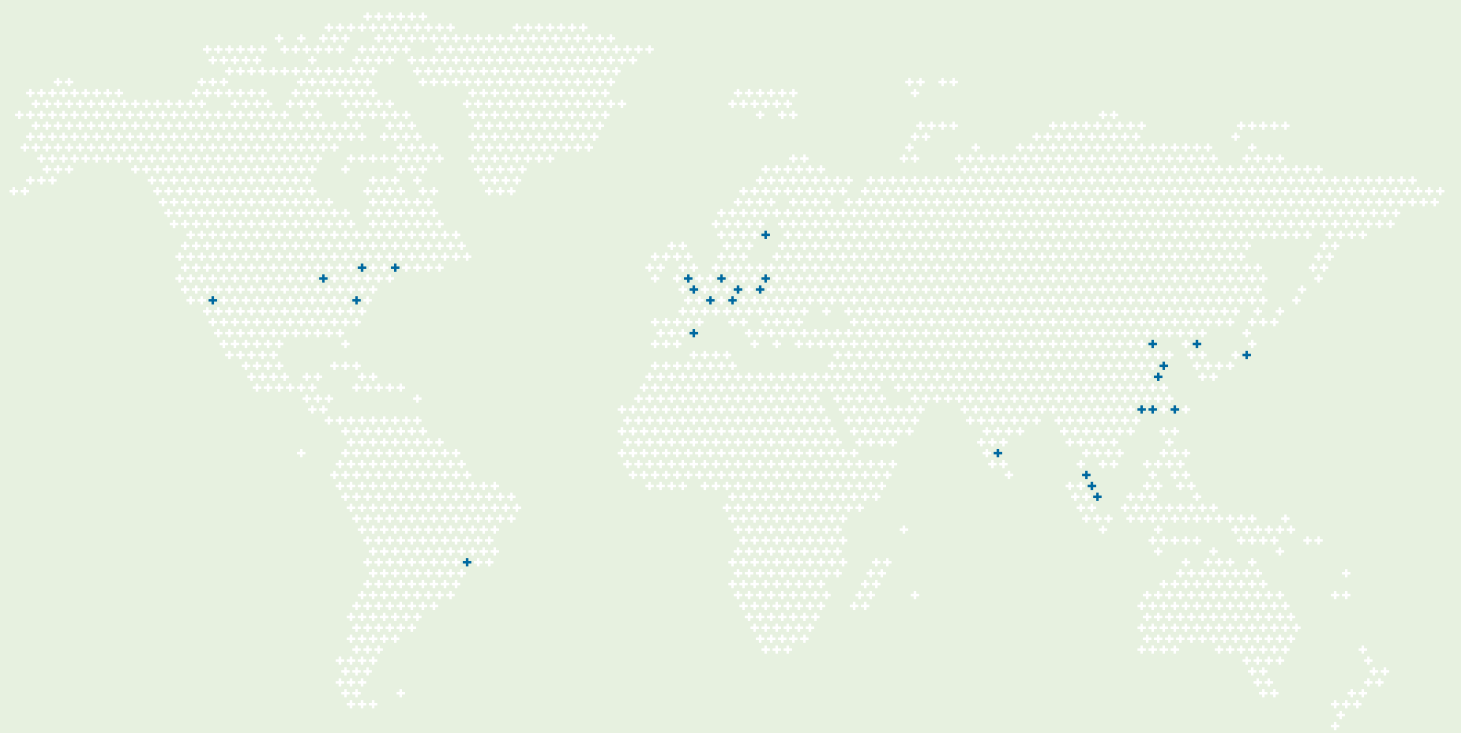

## At a glance

We enable our customers to run their businesses efficiently and effectively by offering innovative Milling, EDM, Laser, Additive Manufacturing, Spindle, Tooling and Automation solutions. A comprehensive package of Customer Services completes our proposition.

[www.gfms.com](http://www.gfms.com)

