

# HELITRONIC VISION 700 L

High-performance tool-grinding machine  
for tools up to 700 mm in total length



## Key features

The HELITRONIC VISION 700 L from the HELITRONIC range is the new benchmark for productivity with long, rotationally symmetrical tools. Tool lengths up to 700 mm, tool diameters from 3 to 200 mm.



Grinding



Eroding



Laser



Measuring



Software



Customer Care

## Walter Maschinenbau GmbH

---

WALTER has produced tool grinding machines since 1953. With the introduction to the market of the HELITRONIC series for the complete machining of rotationally symmetrical tools, WALTER became the leader of the world market. Today, our product range is supplemented by fully automated CNC measuring machines in the HELICHECK series for contact-less complete measurement of tools and production parts.

Walter Maschinenbau GmbH is part of the UNITED GRINDING Group within Körber AG which has significant financial strength and well tested processes. Together with our sister company, Ewag AG, we consider ourselves to be a supplier of systems and solutions for the complete machining of tools and can offer a wide range of products, including grinding, rotary eroding, laser machining, measurement and software.

Our customer focus and our global sales and service network of company-owned locations and employees has been appreciated by our customers for decades.

# HELITRONIC VISION 700 L

The HELITRONIC VISION 700 L is particularly suitable for machining long drills and tools clamped between tips, such as long hob cutters. An automated work table and moving support systems ensure millimetre precision and quality for long tools. Thanks to its grinding wheel changer and robot loader the HELITRONIC VISION 700 L is able to guarantee optimum productivity – from single-item to large-scale production.



Grinding



Software

# The HELITRONIC VISION 700 L at a glance

## Application

- Grinding of rotationally symmetrical tools up to 700 mm in length for the metalwork and woodwork industries
- Example applications include long, deep hole drills and hob cutters clamped between tips, as well as standard milling cutters, multi-step tools, woodwork tools, profile cutters and profile tools
- From single-item to large-scale production
- Fully automated, complete machining with only a single clamping cycle
- Materials include carbide, HSS, ceramic, cermet, CBN

## The machine

- Low vibration, solid mineral cast, gantry type construction (patented)
- X, Y, Z with linear drives
- A, C with torque motors
- Innovative C-axis concept, top arrangement with swivelling grinding wheel
- Motor spindle with one spindle end and up to 3 grinding wheels
- FANUC, the global standard for control equipment

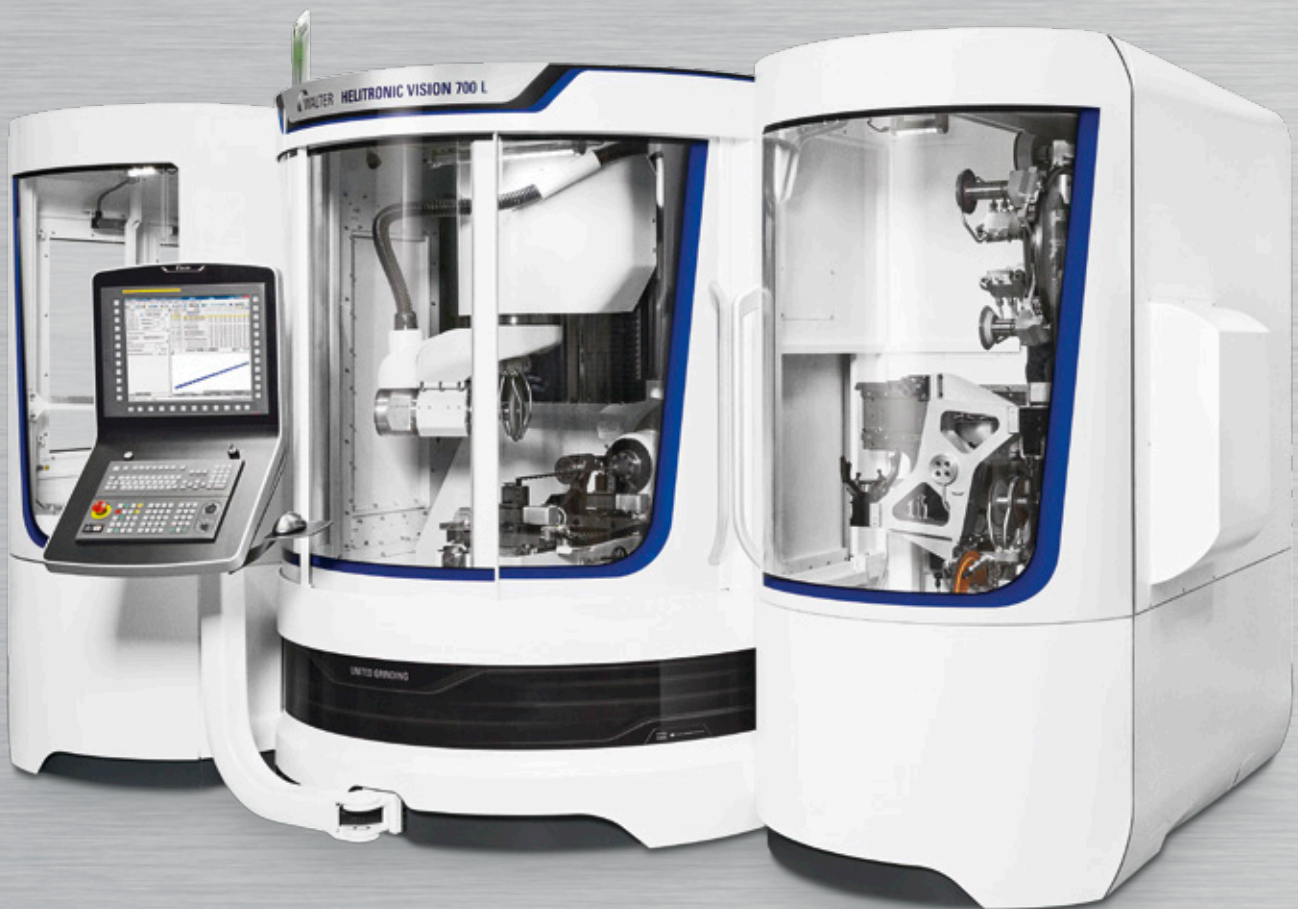

HELITRONIC VISION 700 L with robot loader and grinding wheel changer – the top high-performance version for low manpower multi-shift operation and large series.

## Software

---

- HELITRONIC TOOL STUDIO, CAD/CAM software for design, programming, simulation and production
- Numerous software options to extend the system's performance and to increase its efficiency

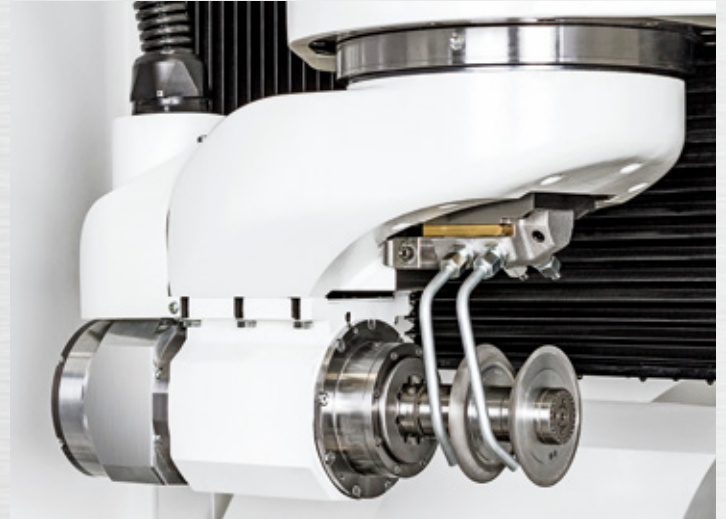

### **The ingenious C-axis concept of the HELITRONIC VISION 700 L**

The motor spindle on the top horizontal C-axis, which is equipped with up to three grinding wheels, swivels around the tool. This innovative machine geometry enables the grinding of longer tools, while maintaining the uniform footprint of the HELITRONIC VISION series. The new machine geometry is made possible thanks to WALTER's powerful HELITRONIC TOOL STUDIO grinding software.

# Geometric precision to the last millimetre

1

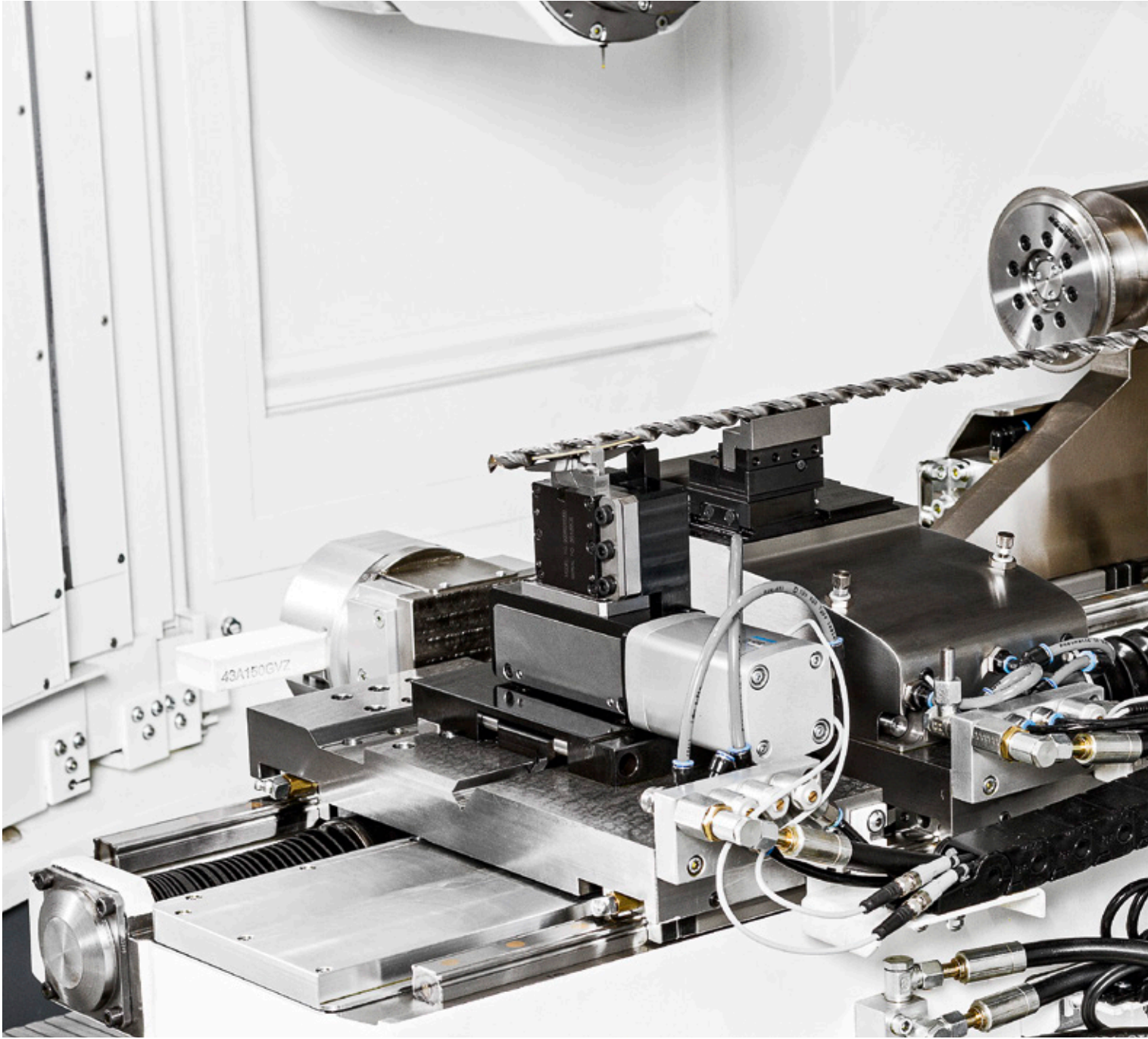

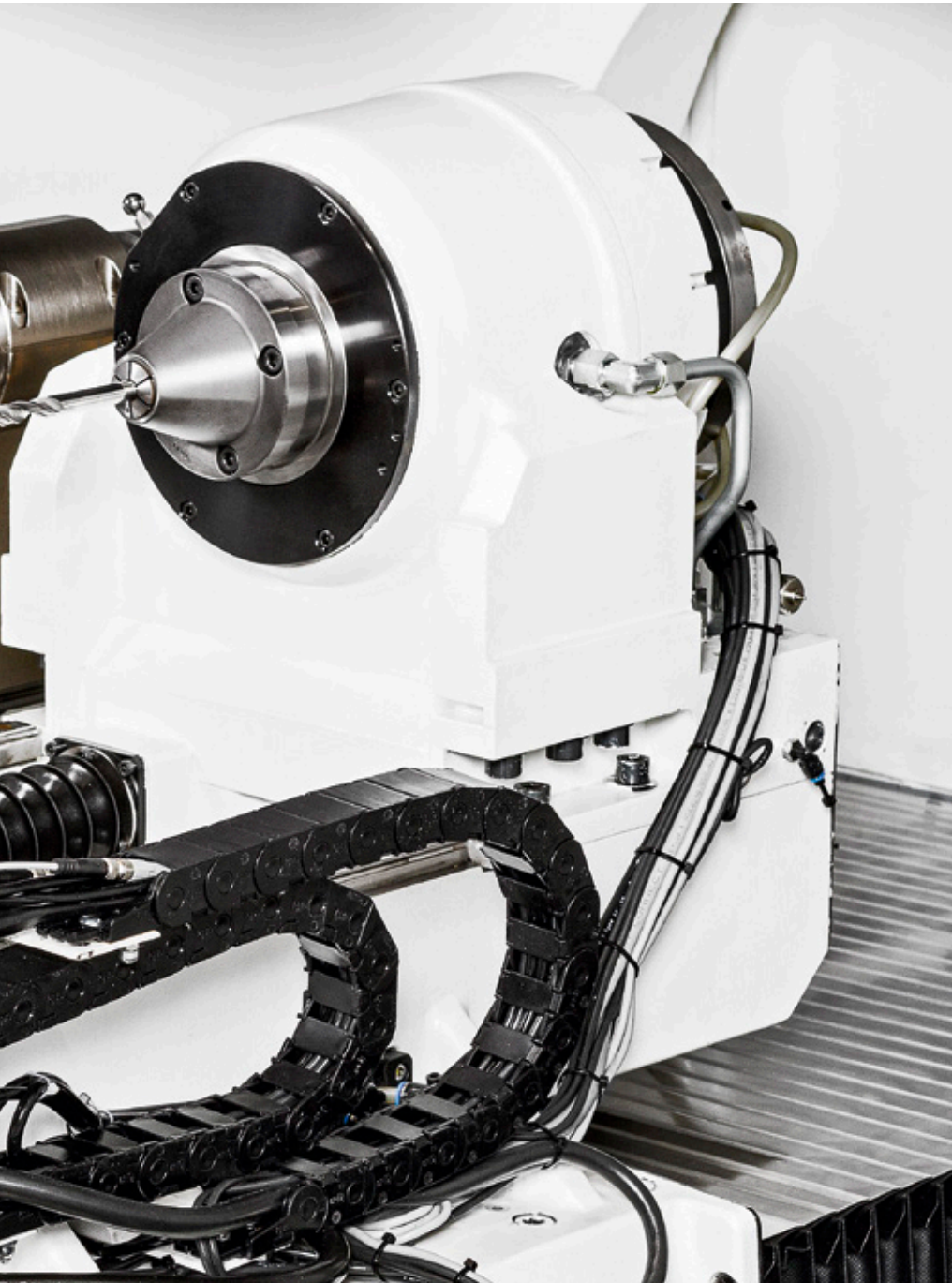

WALTER has developed an automated work table for accommodating a tool support system, which enables the grinding of long, rotationally symmetrical tools with a geometric length of up to 580 mm or a total length of up to 700 mm.

To ensure the support is maintained over the tool's entire geometric length of up to 580 mm, the support system moves parallel to the grinding wheel. In this case, the mobile steady rest is always present as a support system where the grinding wheel comes into contact with the tool. This minimises bending, chatter marks, excessive wear of the wheel and poor surface quality.

The WALTER support system can be equipped with various superstructures, for example, with steady rests or a tailstock depending on the tool being machined. The steady rests have been optimised for the tool, either in the form of a half shell, prism, bush or a special design.

This method ensures a geometry that is precise to the last millimetre.



# Grinding technology of the future

1

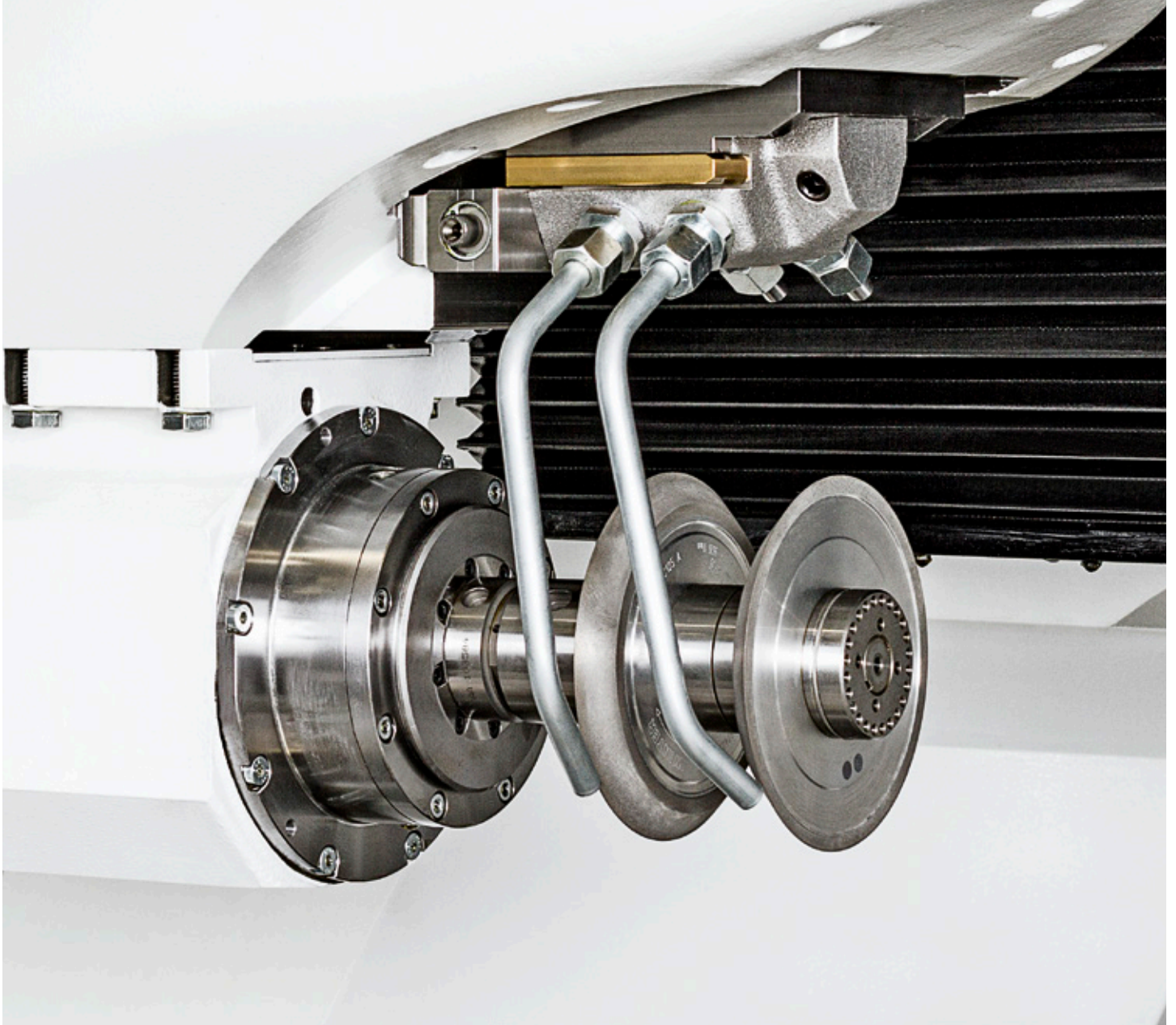

## Motor spindle on a horizontal C-axis

The direct drive motor spindle with a spindle end and a 35 kW peak power is flanged directly to the C-axis. The grinding spindle can be equipped with three grinding wheels. 6, 12 or 24 wheel sets can be incorporated into the grinding process by using the grinding wheel changer. This is sufficient for complex geometries in a single clamping.

- Innovative C-axis kinematics for greater flexibility
- Max. wheel diameter of 254 mm
- Peak power of 35 kW



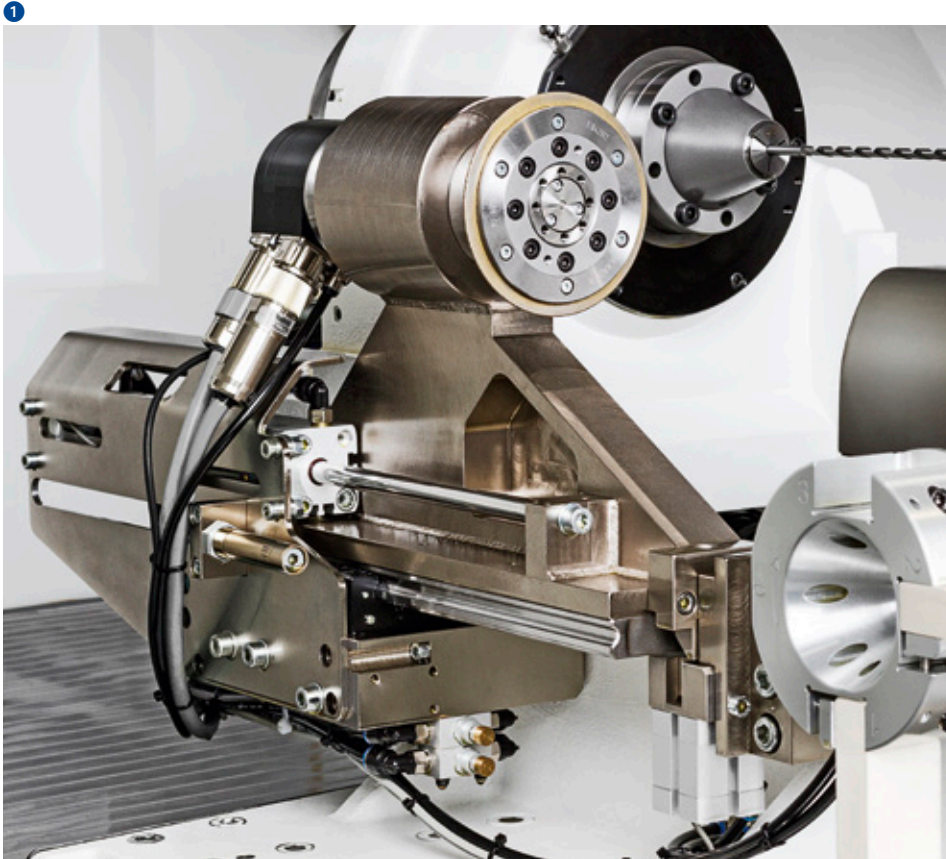

### Grinding wheel dresser

The HELITRONIC VISION 700 L is a high volume machine. To ensure its high performance it requires grinding wheels with extremely durable profiles. The rotary dressing device with diamond rollers regenerates profile wheels by dressing the profiles. This restores runout and grinding quality and significantly enhances the service life of the wheel.

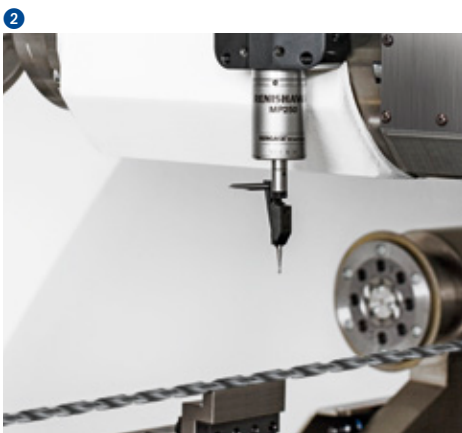

### Automatic positioning and measurement system "Heli-Probe"

Heli-Probe records important tool parameters for a perfectly positioned tool in the shortest space of time. This is the best precondition for quick and accurate grinding, quality and productivity.



### The sharpening stone system extends the service life of the grinding wheels

Up to three different sharpening stones can be mounted depending on the type and number of grinding wheels used in the process. The sharpening stone is used to remove small amounts of resin bond and chips from the grinding wheel and expose the diamonds. The removal rate of the grinding wheel increases and its performance is enhanced at a lower grinding pressure. The sharpening stone prolongs the service life of the grinding wheels and thus the productivity of the HELITRONIC VISION 700 L.

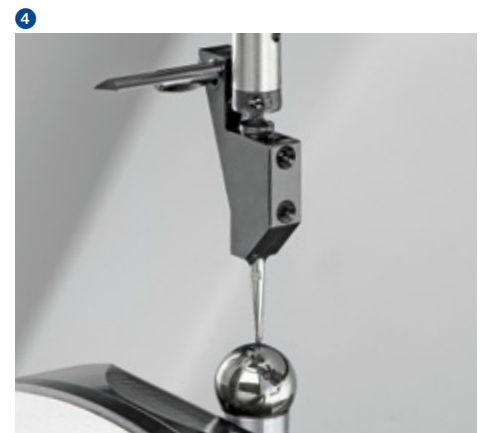

### Calibration

Calibration consists of a calibration ball and software. It is used to automatically calibrate the X, Y and Z axes of the machine with a loader. Any calibration time can be freely chosen in the loader program. Machines without a loading system can be calibrated manually.

# Robot loader and efficiency options



## Integrated FANUC robot loader

The versatile handling capabilities of the robot loader are perfectly coordinated with the flexibility of the HELITRONIC VISION 700 L. The 6-axis robot is design for a fully automatic assembly. It is freely programmable and provides maximum flexibility.

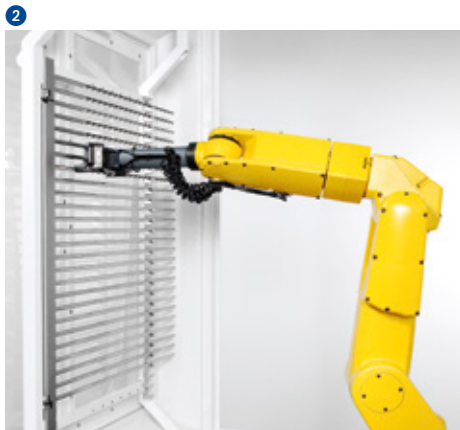

Long tools are stored vertically in a rack. The maximum capacity of the rack is 30 specimens.



Tool storage with horizontal tool pallets and a vertical rack. Utilisation according to the grinding programme. Pallet storage capacity depending on diameter: up to 3,500 blanks. A fourth pallet accommodates the ground tools.

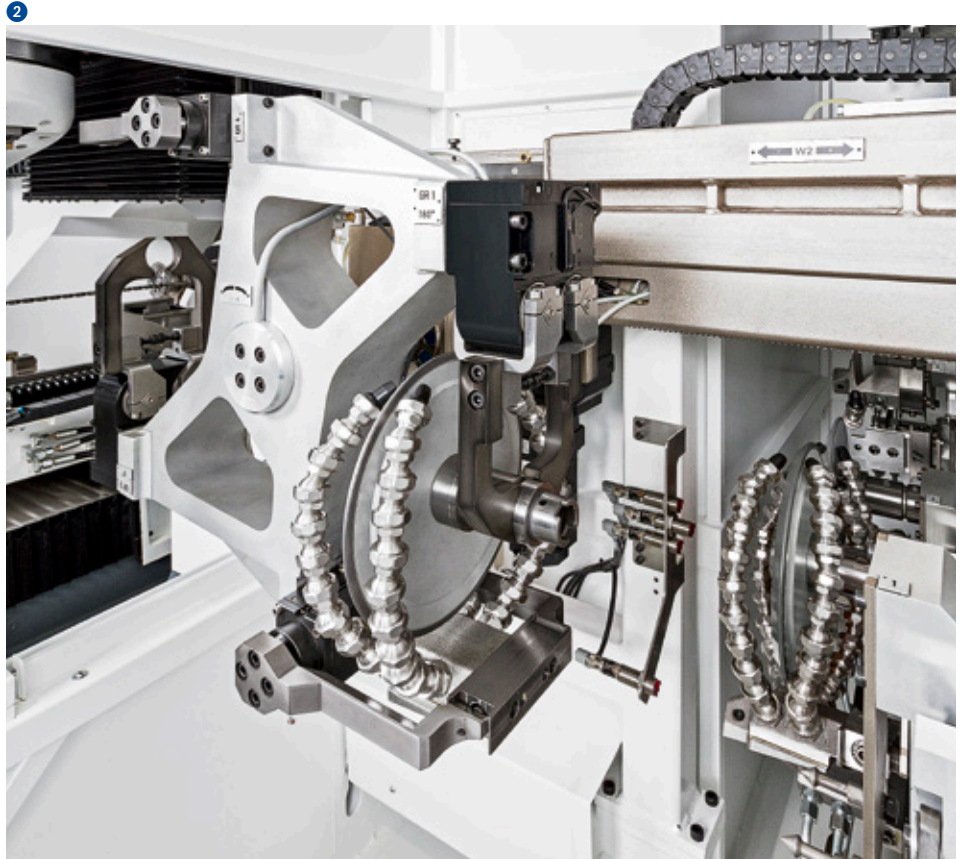
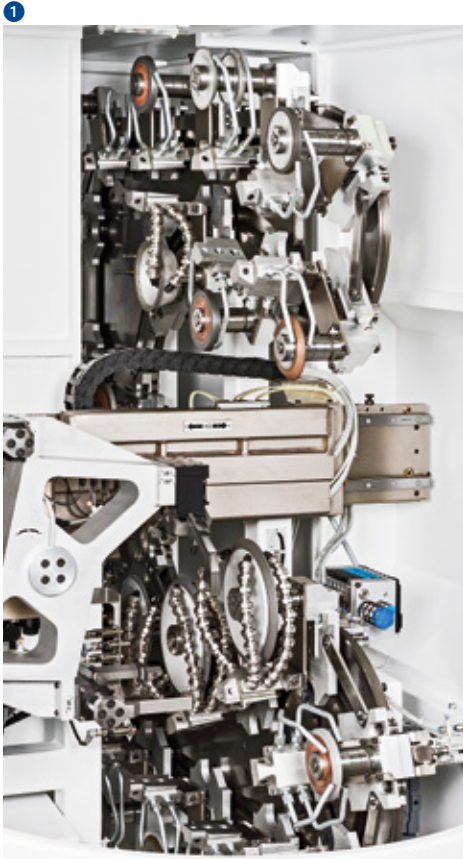

- Time-saving double gripper solution
- Max. wheel diameter of 254 mm
- Max. 72 grinding wheels for stockpiling

### Grinding wheel changer

A real machine enhancement from WALTER. With a capacity of 6, 12 or 24 stations and a maximum of 72 grinding wheels it multiplies the grinding performance of the HELITRONIC VISION 700 L. The wheel set and coolant supply are arranged on the changer as a compact unit. Minimal changing times are ensured thanks to an intelligent double gripper solution. The grinding wheel changer and robot loader pave the way for maximum productivity with complex geometries in multi-shift operation.

# Application software for tool machining

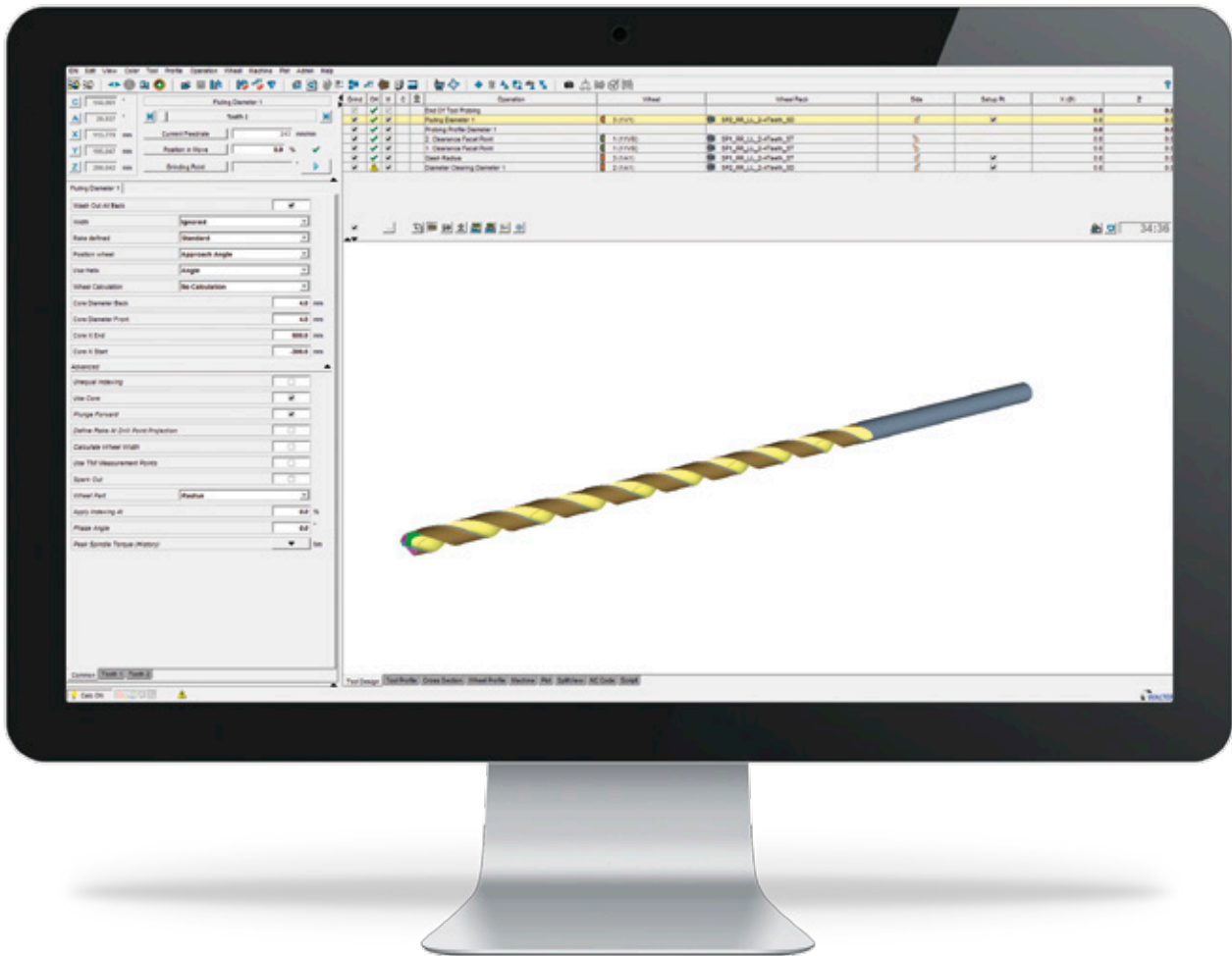

## HELITRONIC TOOL STUDIO adds operational convenience to all grinding applications

HELITRONIC TOOL STUDIO is the WALTER way to the perfect tool. According to the tried and tested method of "What you see is what you grind", just a few mouse clicks are all that separate you from producing the perfect precision tool: Design, programming, simulation and production.

HELITRONIC TOOL STUDIO: This combines ease of programming with the greatest possible flexibility. With the HELITRONIC TOOL STUDIO, only a little work is needed by the user to program machining steps and movement sequences for both rotationally symmetrical standard tools and for

special tools. The tool shown on the screen corresponds exactly to the tool which will then be produced. This means that, as early as the design phase, the result can be checked and, if necessary, corrected thanks to the true-to-life 3D simulation.

The operator can quickly find the tool type, the parameters to be entered and the tool by using the assistant. WALTER provides programme packages for all standard tool families, which make handling significantly easier.

# Efficiency options

- Up to 30 % time saved
- Optimum feed rate
- Optimize existing IDNs

## Feedrate Optimizer

This enhancement to the HELITRONIC TOOL STUDIO provides the ideal options for feed control and for monitoring the grinding wheel and machine load. Depending on the tool type, the time savings can be up to 30%. Feed optimisation uses the findings entered into the HELITRONIC TOOL STUDIO in relation to grinding movements, and the grinding wheel and tool simulation model in order to calculate the current grinding wheel and machine loads and set the optimum feed at any time. Movements with low wheel loads will be accelerated and, this is particularly important, movements where the desired wheel load is exceeded are slowed down. Even existing IDNs can be conveniently optimised with just one click. First, the profile of the grinding wheel load is determined via a progressive simulation analysis. Then, the feed is optimised in such a way that the wheel load remains constant during the entire processing run.

- Permanent set-actual comparison for the torque

## Adaptive Control

By permanently comparing the machine loading, grinding can be made more efficient and simultaneously safer. If the load increases, the feed will be decelerated accordingly. If the load decreases, the speed is increased accordingly. With AC grinding, alternating loads on the grinding wheels will be prevented by a continual load. Any possible overloading of the grinding wheels is excluded.

- Analysis of the centre of gravity
- Balancing the tool

## Tool Balancer

The Tool Balancer is an easy way to analyse, and balance out if necessary, centre-cutting tools with an odd number of flutes (unevenly divided tools) or special tools. The efficiency-increasing method has two core functions: One is to analyse the centre of mass and the other is to automatically balance the tool using different techniques. The approach is simple and can be mastered with just a few mouse clicks. Analysis during the development phase means that the process of prototype production can be significantly shortened. Balanced tools have a longer tool life, can machine at higher speeds, produce higher-quality surfaces and result in less wear-and-tear. Asymmetrical tools are well-suited to machining processes with high rotation speeds up to a point where significant imbalance forces occur.

- Determination of the rake angle, the outer diameter and the core diameter for cylindrical tools

## Integrated Measuring System IMS

With the integrated measuring system IMS, the outside diameter, rake angle and core diameter can be measured using the probe ball without having to unclamp the tool. By setting the tolerances, HELITRONIC TOOL STUDIO can compensate for any deviation of the measured values, e.g. by thermal growth or wheel wear-and-tear, and adjust to the nominal measure and thus prevent scrap. The operator no longer needs to make active adjustments and the dressing cycle of the grinding wheels remains constant. Both increase the efficiency, especially when it comes to large-volume production.

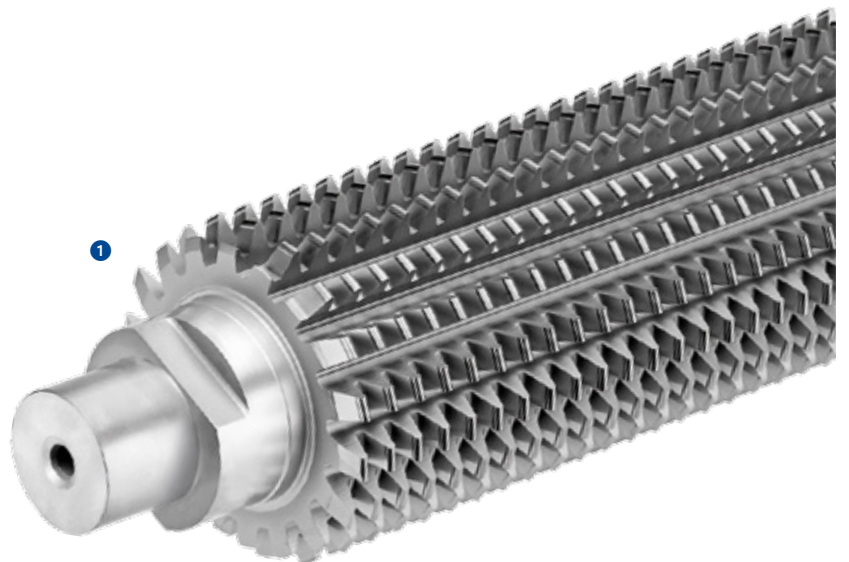

## Global standard of control technology



- Multi-processor system – high system security
- FANUC bus for digital drives – fault-free communication
- CNC and robots from a single manufacturer – no interface problems

With the FANUC control unit, WALTER relies on the global standard of control technology. For the user, this means the highest degree of reliability, availability and operating comfort.

WALTER, the No. 1 in tool machining and FANUC, the No. 1 in CNC control units, together make an unbeatable team.

# Customer Care

WALTER and EWAG deliver systems and solutions worldwide for all areas of tool machining. Our leadership is based on ensuring maximum availability of our machines over their entire service life. For this we have thus bundled numerous services in our customer care program.

From "Start up" through "Prevention" to "Retrofit", our customers enjoy tailor made services for their particular machine configuration. Around the world, our customers can use helplines, which can generally solve a problem using remote service. In addition to that, you will also find a competent service team in your vicinity around the world. For our customers, this means:

- Our team is close by and can quickly be with you.
- Our team will support you to improve your productivity.
- Our team works quickly, focuses on the problem and its work is transparent.
- Our team solves every problem in the field of machining tools, in an innovative and sustainable manner.



## Start up

Commissioning  
Extension of the guarantee



## Qualification

Training  
Support for production



## Prevention

Maintenance  
Inspection



## Service

Customer service  
Customer advice  
Helpline  
Remote service

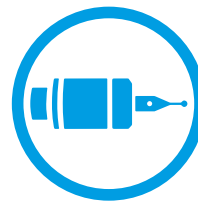

## Material

Spare parts  
Replacement parts  
Accessories



## Rebuild

Machine overhauling  
Refurbishing of assemblies



## Retrofit

Conversions  
Retrofitting parts  
Taking machines back

# Technical data, dimensions

## Mechanical axes

X axis	675 mm
Y axis	255 mm
Z axis	700 mm
Rapid traverse speed X, Y, Z	max. 50 m/min
C axis	± 210°
A axis hollow shaft motor	750 rpm
Linear resolution	0.0001 mm
Radial resolution	0.0001°

## Grinding spindle drive

Max. grinding wheel diameter	254 mm
Grinding spindle speed	0 – 10,500 rpm

### HELITRONIC VISION 700 L with motor spindel

Spindle end for up to 3 grinding wheels	1
Spindle diameter (HSK 50)	100 mm
Peak power	35 kW / 10,500 rpm

## Others

Weight of machine including coolant system	approx. 7,600 kg
Power consumption at 400 V/50 Hz	approx. 35 kVA
Grinding wheel changer for 6 stations	Standard scope of delivery

## Tool data <sup>1)</sup>

Min. tool diameter	3 mm
Max. tool diameter	200 mm
Tool total length	700 mm
Max. workpiece length, peripheral grinding <sup>2)</sup>	580 mm
Max. workpiece length, end face grinding <sup>2)</sup>	550 mm
Production (solid material)	3 – 50.8 (2") mm
Max. unit weight	50 kg

## Options

### Coolant system

Band filter coolant system

### Loading systems

Integrated FANUC robot loader

### Others

Grinding wheel changer for 12 or 24 stations, frequency controlled pump 80 – 120 l/min at 7 – 20 bar, high frequency spindle, automated work table (moving upper plate), internal measuring system IMS, steady rest, tailstock, grinding wheel work equipment, sharpening stone system, calibration device, software

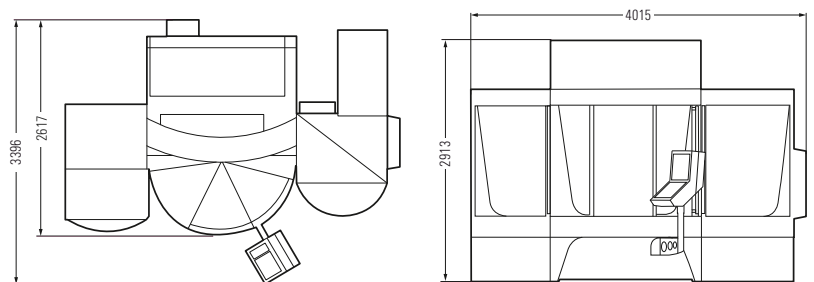

HELITRONIC VISION 700 L with robot loader and grinding wheel changer

<sup>1)</sup> The maximum tool dimensions depend on the type of tool and its geometry, as well as the type of machining.

<sup>2)</sup> From the theoretical taper diameter of the workpiece holder.

Measurements in mm. Subject to modifications due to technical progress and errors. We accept no responsibility for the correctness of any information given.



# Creating Tool Performance

WALTER and EWAG are globally leading market-oriented technology and service companies, and are system and solution partners for all areas of tool machining. Our range of services is the basis for innovative machining

solutions for practically all tool types and materials typical for the market with a high degree of added value in terms of quality, precision, durability and productivity.



## Grinding – Grinding of rotationally symmetrical tools and workpieces

WALTER machines	Use	Materials	Tool dimensions <sup>1)</sup> max. length <sup>2)</sup> / diameter
HELITRONIC ESSENTIAL	P R	HSS TC C/C CBN	255 mm / Ø1 – 100 mm
HELITRONIC MINI POWER	P R	HSS TC C/C CBN	255 mm / Ø1 – 100 mm
HELITRONIC MINI AUTOMATION	P R	HSS TC C/C CBN	255 mm / Ø1 – 100 mm
HELITRONIC BASIC	P R	HSS TC C/C CBN	350 mm / Ø3 – 320 mm
HELITRONIC POWER	P R	HSS TC C/C CBN	350 mm / Ø3 – 320 mm
HELITRONIC VISION 700 L	P R	HSS TC C/C CBN	700 mm / Ø3 – 200 mm
HELITRONIC VISION 400 L	P R	HSS TC C/C CBN	420 mm / Ø3 – 315 mm
HELITRONIC VISION 400	P R	HSS TC C/C CBN	370 mm / Ø3 – 315 mm
HELITRONIC MICRO	P R	HSS TC C/C CBN HSS TC C/C CBN	120 mm / Ø0.1 – 12.7 mm 120 mm / Ø3 – 12.7 mm

EWAG machines	Use	Materials	Tool dimensions <sup>1)</sup> max. length / diameter
EWAMATIC LINEAR	P R	HSS TC C/C CBN PCD	200 mm / Ø0.2 – 200 mm
WS11/WS11-SP	P R M	HSS TC	- / up to Ø25 mm
RS15	P R M	HSS TC C/C CBN PCD	- / up to Ø25 mm



## Eroding – Electrical discharge machining and grinding of rotationally symmetrical tools

WALTER machines	Use	Materials	Tool dimensions <sup>1)</sup> max. length <sup>2)</sup> / diameter
HELITRONIC DIAMOND EVOLUTION	P R	HSS TC C/C CBN PCD	185/255 mm / Ø1 – 165 mm
HELITRONIC POWER DIAMOND	P R	HSS TC C/C CBN PCD	350 mm / Ø3 – 320(400) mm
HELITRONIC DIAMOND	P R	HSS TC C/C CBN PCD	370 mm / Ø3 – 320(400) mm



## Software – The intelligence of tool machining and measuring for production and regrinding



## Customer Care – Comprehensive range of services



## Grinding – Grinding of indexable inserts

EWAG machines	Use	Materials	Indexable inserts <sup>1)</sup> Inscribed / circumscribed circle
EWAMATIC LINEAR	P R	HSS TC C/C CBN PCD	Ø3 mm / Ø50 mm
COMPACT LINE	P R	HSS TC C/C CBN PCD	Ø3 mm / Ø50 mm
INSERT LINE	P R	HSS TC C/C CBN	Ø3 mm / Ø75 mm
RS15	P R M	HSS TC C/C CBN PCD	- / up to Ø25 mm



## Laser – Laser machining of indexable inserts and/or rotationally symmetrical tools

EWAG machines	Use	Materials	Tool dimensions <sup>1)</sup> max. length / diameter
LASER LINE ULTRA	P R	TC C/C CBN PCD CVD-D MCD/ND	250 mm / Ø0.1 – 200 mm
LASER LINE PRECISION	P R	CBN PCD CVD-D	250 mm / Ø0.1 – 200 mm

EWAG machines	Use	Materials	Indexable inserts <sup>1)</sup> Inscribed / circumscribed circle
LASER LINE ULTRA	P R	TC C/C CBN PCD CVD-D MCD/ND	Ø3 mm / Ø50 mm
LASER LINE PRECISION	P R	CBN PCD CVD-D	Ø3 mm / Ø50 mm



## Measuring – Contactless measurement of tools, workpieces and grinding wheels

WALTER machines	Use	Tool dimensions <sup>1)</sup> max. length <sup>2)</sup> / diameter
HELICHECK PRECISION	M	420 mm / Ø1 – 320 mm
HELICHECK ADVANCED	M	420 mm / Ø1 – 320 mm
HELICHECK PRO	M	300 mm / Ø1 – 200 mm
HELICHECK PRO LONG	M	730 mm / Ø1 – 200 mm
HELICHECK PLUS	M	300 mm / Ø0.1 – 200 mm
HELICHECK PLUS LONG	M	730 mm / Ø0.1 – 200 mm
HELICHECK 3D	M	420 mm / Ø3 – 80 mm
HELISSET UNO	M	400 mm / Ø1 – 350 mm
HELISCALE	M	300 mm / Ø1 – 50 mm

**Use:** P Production R Regrinding M Measuring

**Materials:** HSS High speed steel TC Tungsten carbide C/C Cermet/ceramics CBN Cubic boron nitride PCD Polycrystalline diamond CVD-D Chemical vapour deposition MCD/ND Monocrystalline diamond/natural diamond

<sup>1)</sup> Maximum tool dimensions are dependent on the tool type and geometry, as well as the type of machining.

<sup>2)</sup> From the theoretical taper diameter of the workpiece holder.







Walter Maschinenbau GmbH  
Jopestr. 5 · D-72072 Tübingen  
Tel. +49 7071 9393-0  
Fax +49 7071 9393-695  
info@walter-machines.com

For worldwide contact details, please visit  
**[www.walter-machines.com](http://www.walter-machines.com)**

