

PROFIMAT MC/RT

The compact production machine



Key data

Whether precision, profile, internal or external cylindrical grinding – the PROFIMAT MC is a highly efficient grinding centre for any application.

Equipped with the relevant accessories – such as automatic tool changer – the PROFIMAT MC is even suitable for combination machining.

The PROFIMAT RT with rotary table is the perfect grinding solution for the production of large batch sizes or for series production.

PROFIMAT MC/RT

Blohm Jung GmbH

Productivity, performance and precision – three attributes which users worldwide associate with surface and profile grinding machines from BLOHM and JUNG. Our machines have been in use worldwide for decades in widely varying fields of application and under very different conditions.

The experience gained from over 35,000 delivered machines is constantly incorporated into further developments and innovations, increasing our customers' production efficiency even further. The product portfolio of Blohm Jung GmbH extends from surface grinding machines through application-oriented universal machines to customer-oriented production machines. Our service and technology specialists support our customers throughout the entire lifecycle of the machine. From grinding tests through training and maintenance contracts to retrofits, we offer our customers prompt and personal advice.

In 2008 the two established brands BLOHM and JUNG merged under one roof. Blohm Jung GmbH has thus combined its extensive know-how and constantly enables new, higher standards in the area of precision, quality and cost efficiency. There are also many opportunities for tailoring production solutions to individual customer requirements.

As part of the UNITED GRINDING Group, Blohm Jung GmbH is represented internationally with offices in India, China, Russia and the USA. A further 40 sales and service agencies guarantee a worldwide presence and customer proximity. The company's main locations are the development and production facility in Hamburg and the service and technology center in Göppingen.

Different spindle variants enable diverse applications. The six-axis CNC profile grinding machines can be equipped with a horizontal spindle for drive capacities up to 60 kW as well as a stationary or an NC-swiveling vertical spindle.

The high-performance PROFIMAT RT is the perfect production machine. Low set-up costs combined with high efficiency and the possibility of simple adaptation of automatic workpiece change systems set benchmarks in modern and cost-effective production.

Characteristics

Dimensions

- PROFIMAT MC with grinding ranges from 600 x 700 to 600 x 1,000 mm
- PROFIMAT MC with vertical spindle: Rotary table diameter up to 1,200 mm
- PROFIMAT RT with rotary indexing table diameter 1,000 mm

Hardware

- Traveling column design
- Rigid machine structure due to wide spacing of guideways
- High infeed speeds and accelerations

Software

- Siemens 840D solution line
- Safety integrated, safe axis monitoring
- Extensive operator guidance

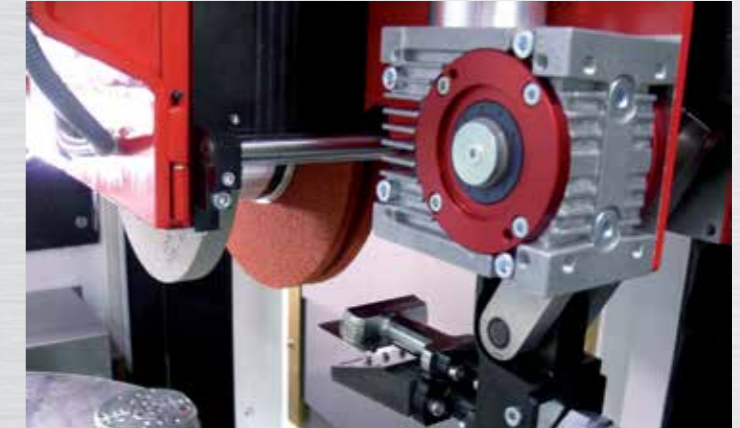

RazorTec, new way of grinding wheel cleaning, with newly developed nozzle positioner, 30% less grinding wheel wear, 30-40 bar nozzle pressure

Extremely compact in size, the PROFIMAT MC employs the latest grinding technology for flexible use in various applications. The optional tool changer and other machine-specific accessories open up broad fields of application.

Grinding spindle drives with a power of up to 60 kW and a max. cutting speed of 170 m/s guarantee outstanding performance using conventional, CD- or IPD as well as any CBN grinding methods.

Pre-loaded anti-friction guideways in all machine axes guarantee the necessary system rigidity and reduce maintenance requirements. The extremely efficient BLOHM software ensures exact interpolation of the axes and thus high workpiece quality.

A broad range of standard accessories and special workpiece clamping and handling systems enable quick adaptation to customized production tasks with high cost efficiency and quality.

High flexibility with a modular system

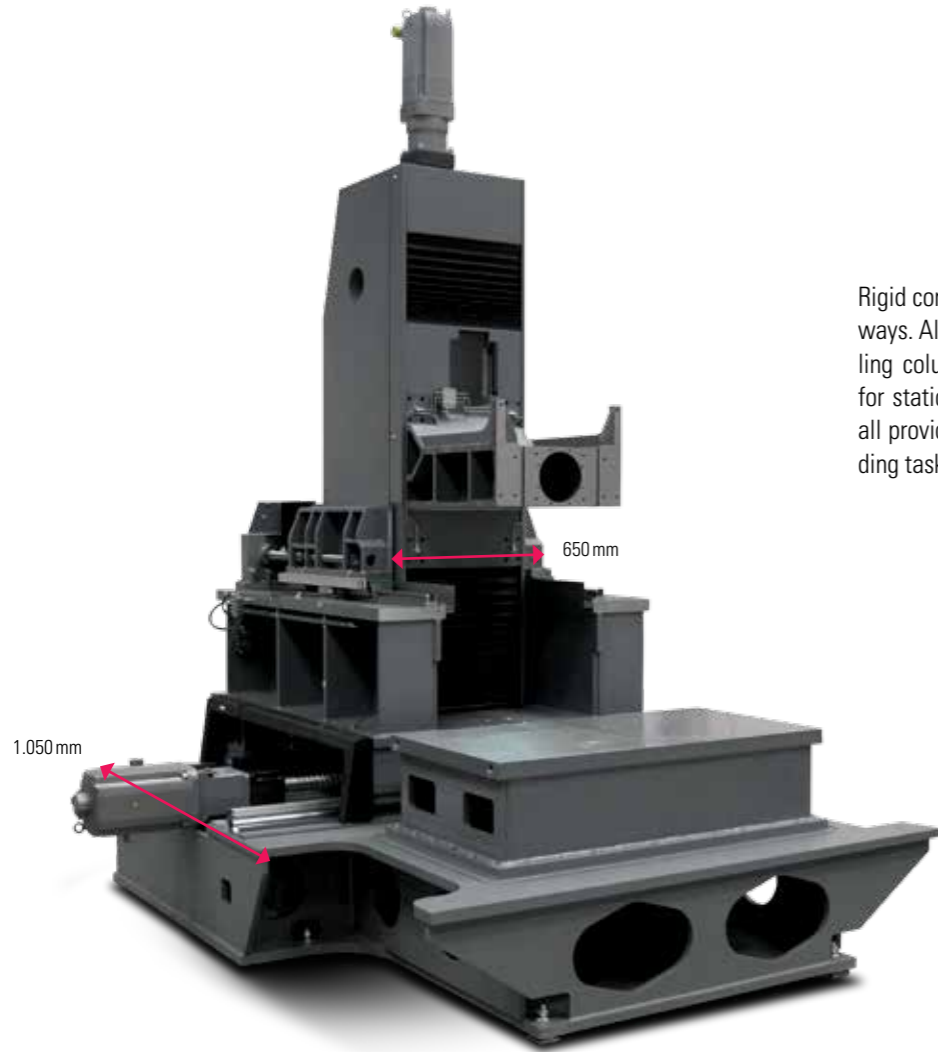

Rigid construction due to wide spacing of guideways. All models in this series feature the travelling column design with various configurations for stationary table, rotary table or index table, all providing the optimum solution for your grinding tasks.

Grinding spindle drive power curves

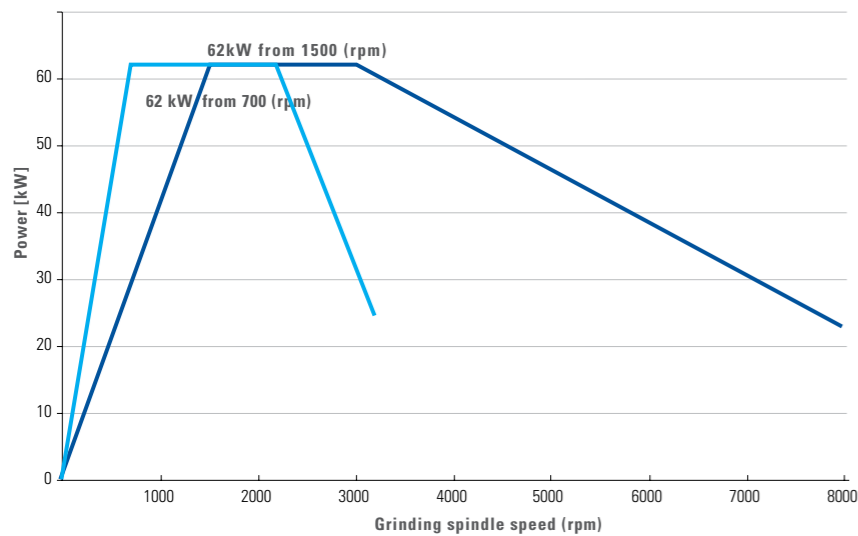

Established construction principle



Z-axis with linear guideways, ground re-circulating ballscrews and linear glass measuring system



Z-axis with parallel drive system for increased rigidity (optional)

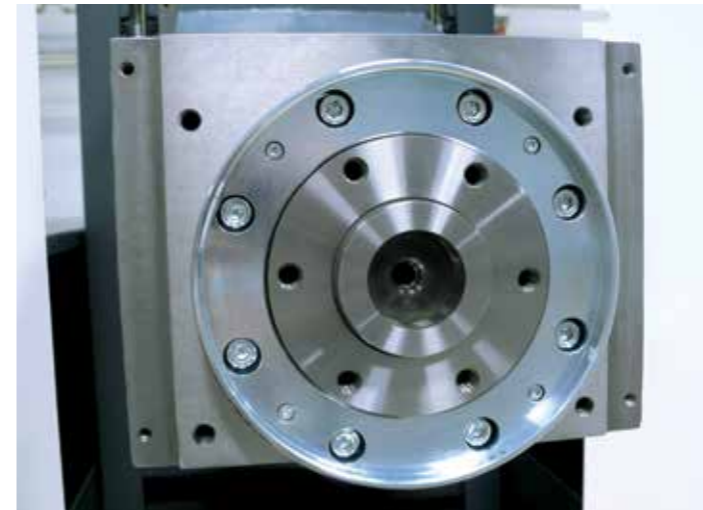

Cartridge type spindle with short taper for repeatable grinding wheel positioning

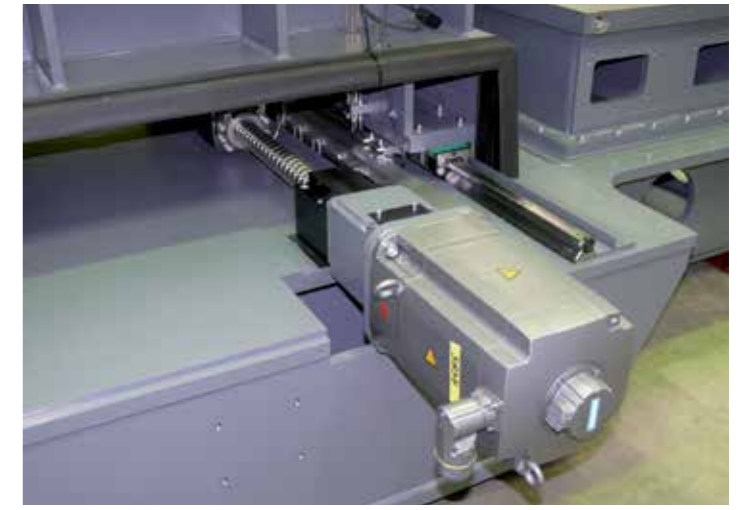

X-axis with linear guideways, ground re-circulating ballscrews

Process optimized accessories



Single spindle **CD-dressing system** mounted on wheel hand (V-axis)



Double spindle **CD-dressing system** mounted on wheel head (E-axis)



Double CNC indexing table for 5-axis continuous path controlled profile grinding

Accessories like

- Single or double CNC indexing tables
- Integrated automatic gauging systems
- Dressing systems mounted on the machine table and/or grinding wheel head offer a wide variety of customer specific solutions.

Tool changing system



Tool changing systems with up to 24 tools permit complete machining of complex parts in one set-up using conventional and CBN grinding wheels as well as drilling and milling tools.

Tool changing systems with up to 24 tools
12 x D=300 or 8 x D=400

CNC Control

The convenient solution for profile grinding applications

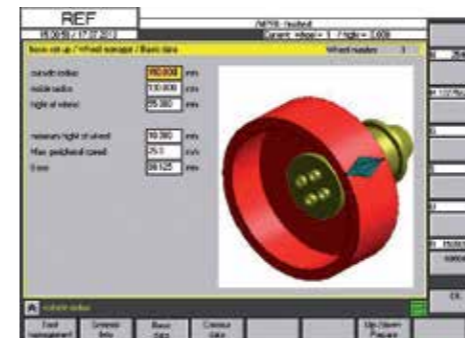

Input screen for a cup wheel

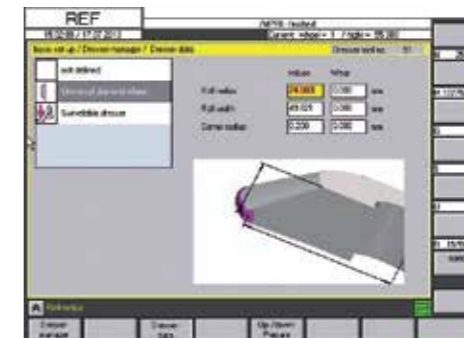

Input screen for a dresser

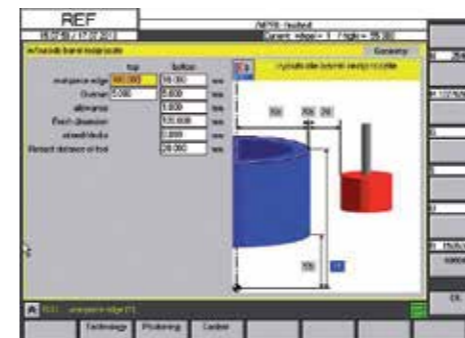

Parameter input screen for the external cylindrical grinding cycle

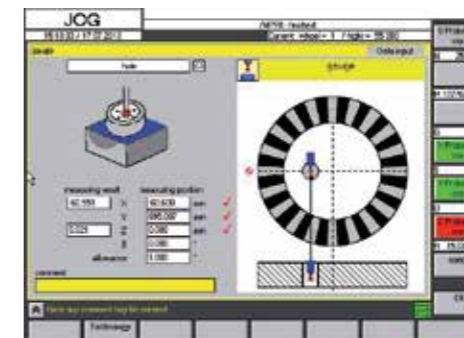

Parameter input screen for the hole measuring cycle

Versions

PROFIMAT MC 607 with tool changing system



PROFIMAT RT1000

The PROFIMAT RT features an indexing table and reduces non-productive times due to loading/unloading while grinding.

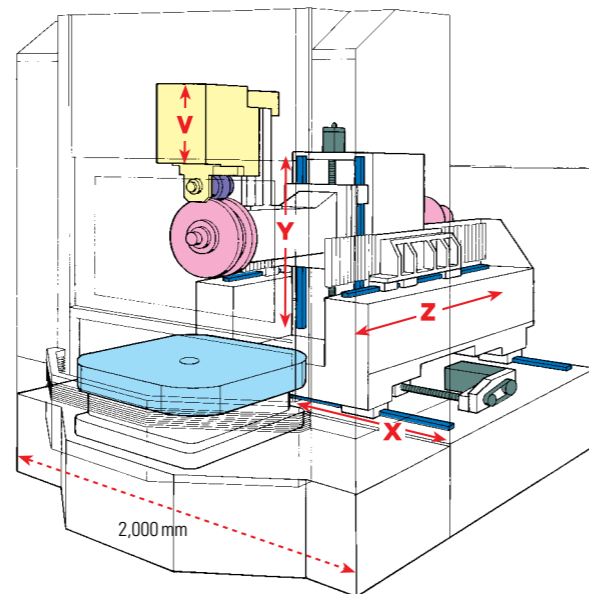

PROFIMAT MC 610VS

The PROFIMAT MC 610VS has been designed for ID and/or OD grinding of rotation-symmetric workpieces up to 1,200 mm in diameter and is equipped with vertical or CNC controlled tilting grinding spindle for a wide range of applications.

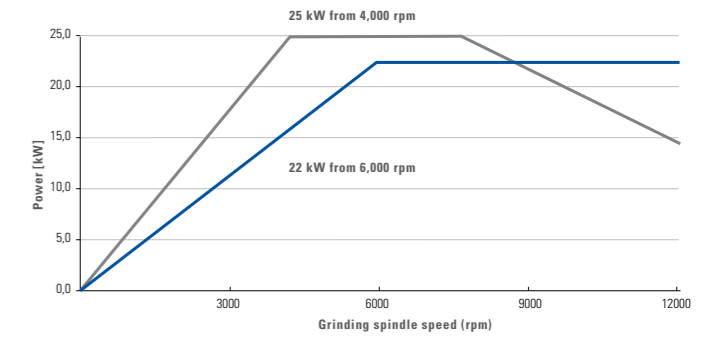

PROFIMAT MC 610VS with CNC controlled tilting grinding spindle



PROFIMAT MC 610VS with vertical grinding spindle



CNC dressing with rotary diamond disk

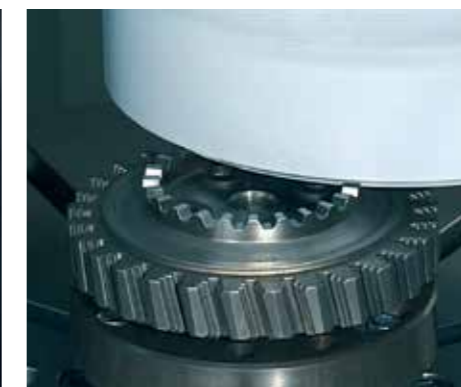

Curvic coupling face gear



CNC dressing with single point diamond

BLOHM solutions

Automotive industry and suppliers



Steering racks (MC 607)



Piston rack nut (RT1000)



Turbine industry



Turbine blade (MC 607)

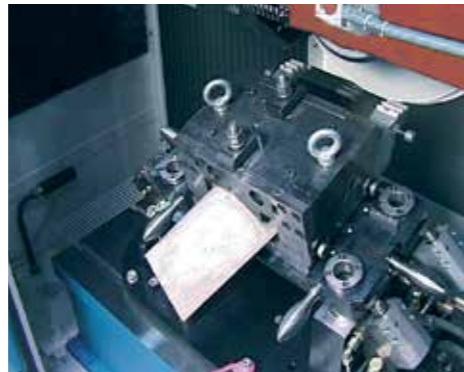

Stationary gas turbine blade 800 mm (MC 607)



Turbine vane segment (MC 607 VG)

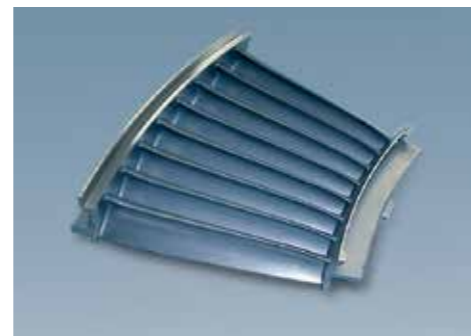

Machine building

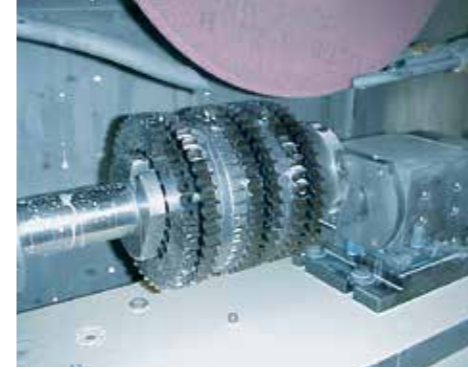

Transfer drum (MC 607)

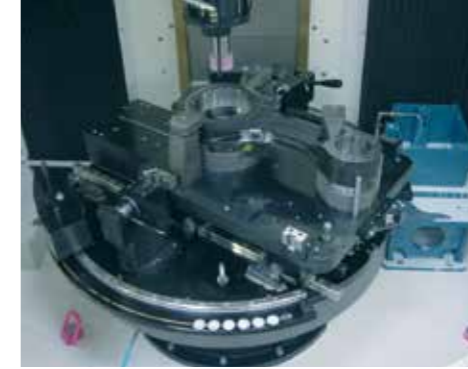

Connecting rod for marine diesel engine (MC 610VS)



Tool and Die



Knife (RT1000)

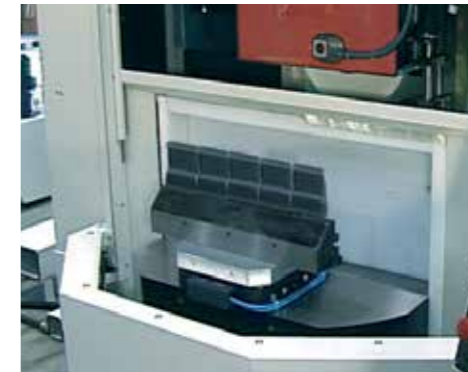

Press break tool (RT1000)



Press break tool (MC 607)

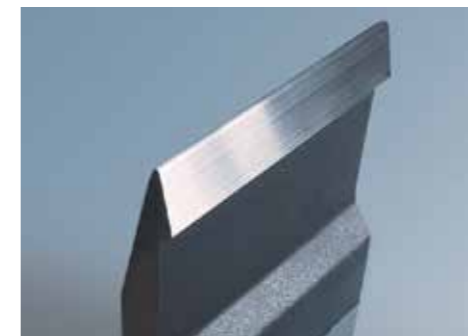
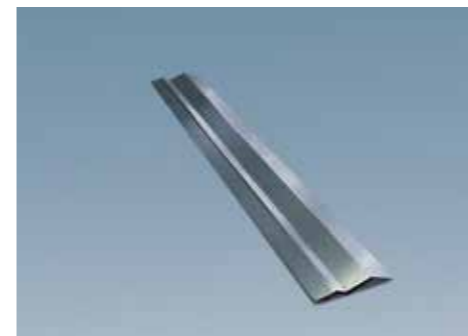

Customer Care

BLOHM and JUNG surface and profile grinding machines should fulfill the customers requirements for as long as possible, work cost-effectively, function reliably and be available at all times. From "start up" through to "retrofit" – our Customer Care is there for you throughout the working life of your machine. 6 professional helplines and more than 25 service technicians are available in your area, wherever you are in the world.

- We will provide you with fast, uncomplicated support.
- We will help to increase your productivity.
- We work professionally, reliably and transparently.
- We will provide a professional solution to your problems.



Start up
Commissioning
Warranty extension



Qualification
Training
Production support



Prevention
Maintenance
Inspection



Service
Customer service
Customer consultation
HelpLine
Remote service

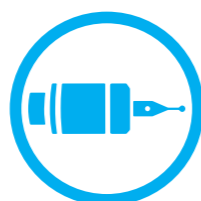

Material
Spare parts
Replacement parts
Accessories



Rebuilt
Machine overhaul
Assembly overhaul



Retrofit
Modifications
Retrofits
Machine trade-in

Technical data

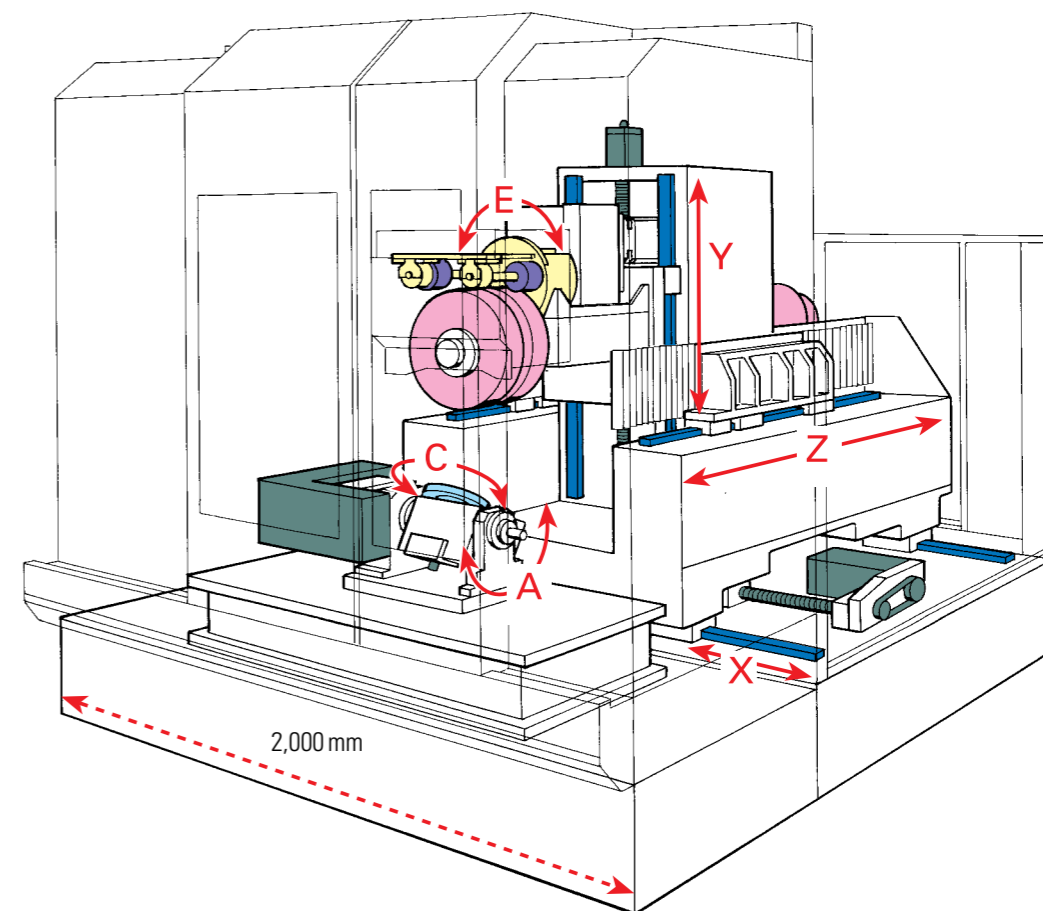

PROFIMAT		MC 607	MC 610	MC 610 VS	RT 1000
Grinding range	mm	600x700	600x1,000	600x1,000	–
Indexing table, diameter	mm	–	–	600...1,200	1,000
X-axis, column longitudinal travel	mm	700	1,000	1,000	1,000
Y-axis, wheel head vertical travel	mm	650	550 ²⁾	800	550
Z-axis, column cross travel	mm	520	520	320	520
A-axis, indexer range (optional)	deg		+ 105 / –90		
C-axis, indexer, range (optional)	deg		360		
E-axis, stroke of head mounted dresser (opt.)	mm	–	–	–	–
V-axis, stroke of head mounted dresser (opt.)	mm	130	130	–	130
Grinding spindle drive power, revolution	kW/rpm		bis 60/8,000		
Grinding wheel (d x w x bore), max.	mm	500x200x127	500x200x127	500x100x127	500x200x127
Dimensions width	mm	2,400	2,380	2,380	2,380
depth	mm	4,200	4,100	4,400	4,100
height	mm	3,200	3,000	3,500	2,900
Weight (machine without electr. cabinet)	kg	8,500	7,500	9,000	6,700

¹⁾ Option 1,200 mm ²⁾ Option 800 mm

We reserve the right to make technical changes



Blohm Jung GmbH

Location Hamburg

Kurt-A.-Körper-Chaussee 63-71
D-21033 Hamburg
Phone +49 40 72 50 02
Fax +49 40 72 50 32 87
sales-hh@blohmjung.com

Location Göppingen

Jahnstraße 80-82
D-73037 Göppingen
Phone +49 7161 612 0
Fax +49 7161 612 170
sales-gp@blohmjung.com

www.blohmjung.com

